



Viva Dual Access Animal Containment Workstation, Model VDA-4A_



Viva Universal Animal Containment Workstation, Model VA2-4A_E



Viva Animal Bedding Disposal Workstation, Model VBD-4A_

Animal Containment Workstation

The Portable Safety Solution for Animal Research Laboratories

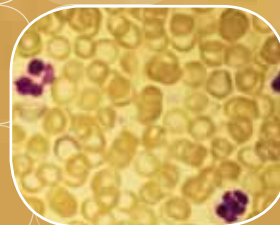

ESCO

WORLD CLASS. WORLDWIDE.

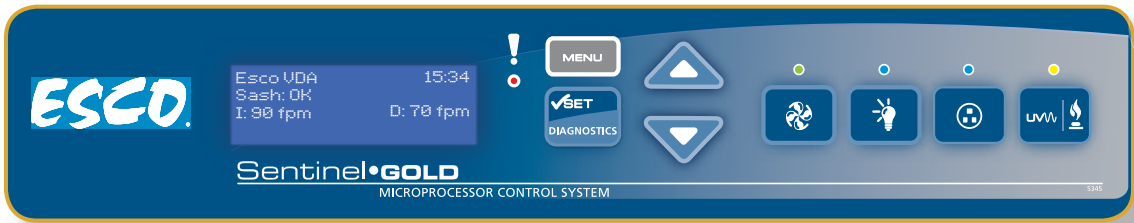

Airflow Sensor

- Monitors real-time airflow for safety
- Alert the user if airflow is insufficient

Sentinel™ Gold Microprocessor Controller

- Displays all safety information on one screen
- Centered and angled down for easy reach & viewing
- Selectable Quickstart mode for fast operation



Easy to clean Work Surface and Drain pan

- Two-pieces Stainless Steel Tray, easy to lift.
- Drain hole on both sides to dump animal bedding.



Easy Work Access

- Large 354 mm (14") Access Opening.
- Accommodates rat and mouse cages.
- Hinged up for easy cleaning.



Advanced Work Tray Design

- V-shaped Grill to avoid blocking.
- Center Grill to separate Work zone to clean & dirty area.
- Large Tray handle for easy lift.



Comfortable Leg Room

- 254 mm (10") Leg Room on BOTH sides.
- Reduce fatigue for sitting position.
- Hydraulic Motor to adjust height.

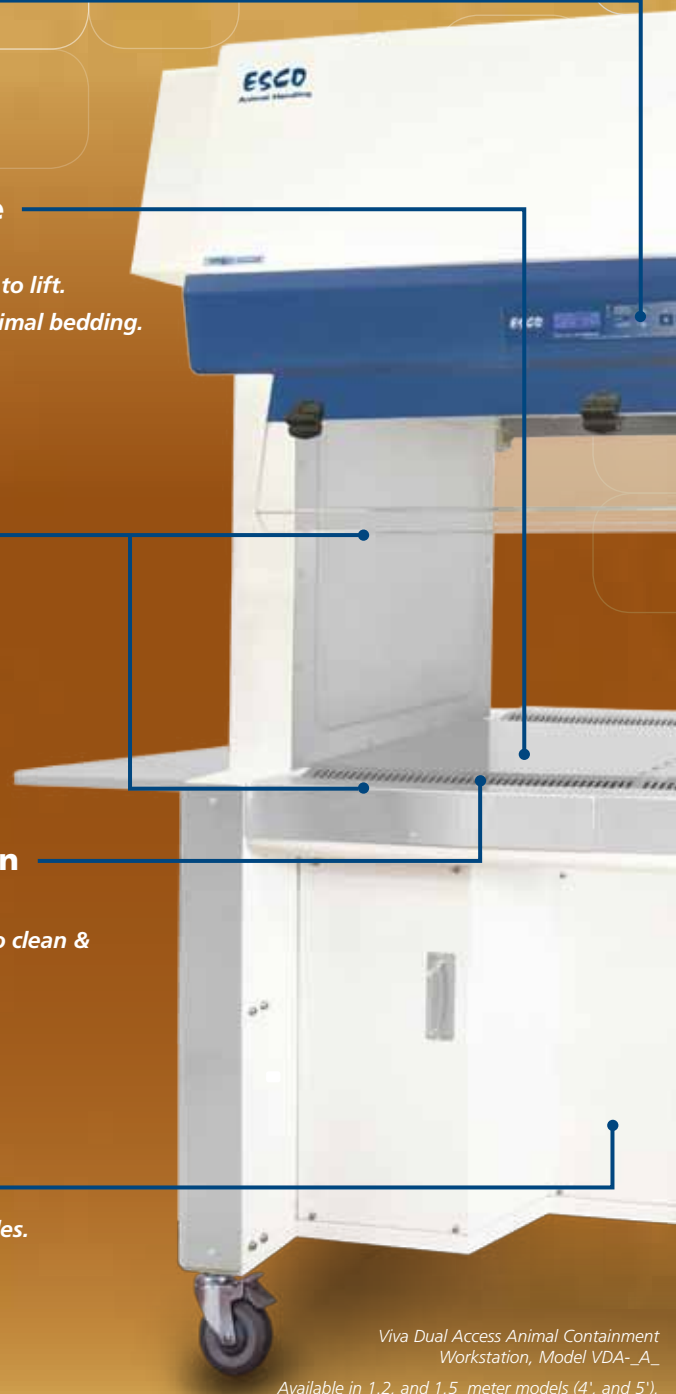

Viva Dual Access Animal Containment Workstation, Model VDA- _A_ Available in 1.2, and 1.5 meter models (4', and 5').

Accessories and Options

Contact Esco or your Esco Sales Representative for details.

- Electrical Outlets
- Side Shield
- Foldable Side Tray
- Feed Hopper



Side Shield



Feed Hopper





ELISA Proven Containment

- Provides >99% Allergen Containment.
- Ensures User's Safety.



VIVA

ULPA Filter

- 10x Filtration efficiency of HEPA filter
- Creates ISO Class 3 work zone instead of industry-standard ISO Class 5

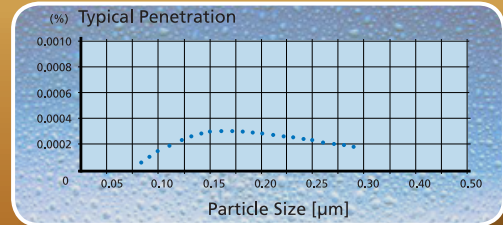

Quiet Operation

- The quietest Dual-Access Animal Workstation in the world, at 53 dbA in open field condition
- Comfortable for the operator and animals



ISOCIDE™ Powder Coat

- Silver-ion impregnated powder coat
- Inhibit microbial growth to improve safety

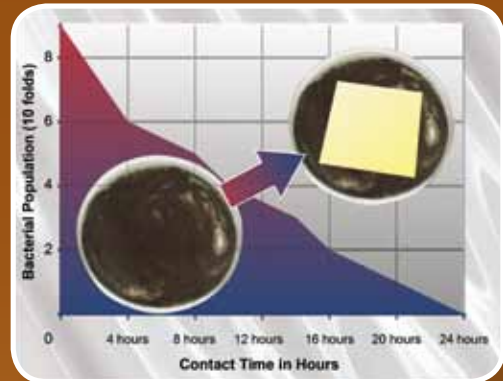

Dual Energy Efficient DC ECM Motor

- Powered by latest generation DC ECM motor, that is more efficient than legacy ECM and VFD motors
- 70% Energy savings compared to AC motor
- Stable airflow, despite building voltage fluctuations & filter loading

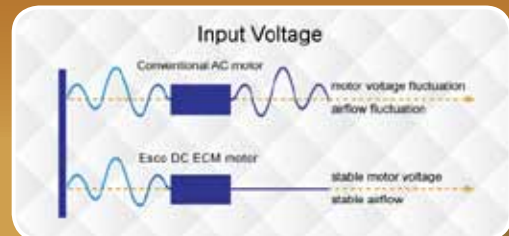

Standards Compliance

Air Quality
 ISO 14644.1, Class 4, Worldwide
 JIS B9920, Class 4, Japan
 JIS BS5295, Class 4, Japan
 US Fed Std 209E, Class 10 USA

Filtration
 EN-1822 (H14), Europe
 IEST-RP-CC001.3, USA
 IEST-RP-CC007, USA
 IEST-RP-CC034.1, USA

Electrical Safety
 UL-61010A-1, USA
 CSA22.2, No.1010-192, Canada
 EN61010-1, Europe
 IEC61010-1, International



Airflow Sensor

- Monitors real-time airflow for safety
- Alert the user if airflow is insufficient

Sentinel™ Gold Microprocessor Controller

- Displays all safety information on one screen
- Centered and angled down for easy reach & viewing
- Selectable Quickstart mode for fast operation



Single-Piece Wall

- Large radius for easy cleaning
- Side-mounted electrical outlets and staggered service fixtures, for easy reach



Single-Piece Work Tray

- Recessed to contain spillage
- Curved grill to prevent blockage



Raised Arm Rest

- Helps prevent grille blocking
- Comfortable working posture



Angled Drain Pan

- Helps prevent grille blocking
- Does not harbor contaminants



Viva Universal Animal Containment Workstation, Model VA2-A-E
Available in 1.2, and 1.8 meter models (4', and 6').

**EN 12469
COMPLIANT**





Energy Efficient DC ECM Motor

- Powered by latest generation DC ECM motor, that is more efficient than legacy ECM and VFD motors
- 70% Energy savings compared to AC motor
- Stable airflow, despite building voltage fluctuations & filter loading

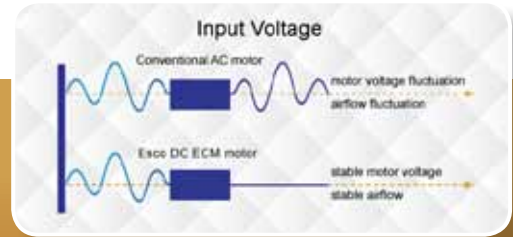

ULPA Filter

- 10x Filtration efficiency of HEPA filter
- Creates ISO Class 3 work zone instead of industry-standard ISO Class 5

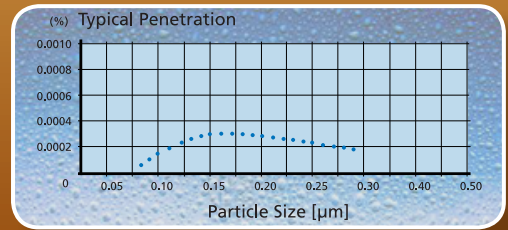

ISOCIDE™ Powder Coat

- Silver-ion impregnated powder coat
- Inhibit microbial growth to improve safety

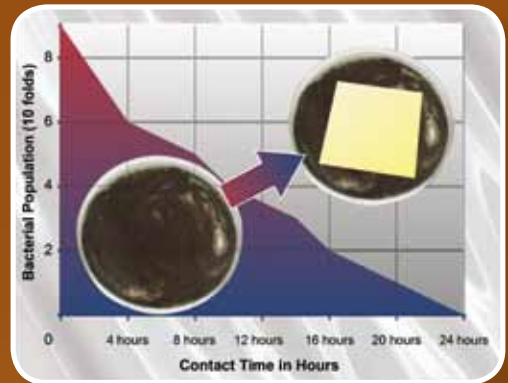

ELISA Proven Containment

- Provides >99% Allergen Containment.
- Ensures User's Safety.



| Standards Compliance | Air Quality | Filtration | Electrical Safety |
|----------------------|--|---|--|
| | ISO 14644.1, Class 3, Worldwide JIS B9920, Class 3, Japan JIS BS5295, Class 3, Japan US Fed Std 209E, Class 1 USA | EN-1822 (H14), Europe IEST-RP-CC001.3, USA IEST-RP-CC007, USA IEST-RP-CC034.1, USA | UL-61010A-1, USA CSA22.2, No.1010-192, Canada EN61010-1, Europe IEC61010-1, International |



Sentinel™ Silver Microprocessor Controller

- Displays all safety information on one screen
- Centered and angled down for easy reach & viewing
- Selectable Quickstart mode for fast operation



Bang Bars

- Increase efficiency of bedding disposal operations.



Integrated Waste Chute

- Dispose refuse bag safely within the work zone



Operator and Environmental Protection

The VIVA Bedding Disposal Workstation provides operator and environmental protection from animal allergen.



Exclusive hydraulic height-adjustable stand

Allows the work surface height to be adjusted to user preference therefore minimizing strain during repetitive operations.



Airflow Sensor

- Monitors real-time airflow for safety
- Alert the user if airflow is insufficient

Viva Animal Bedding Disposal Workstation Model VBD-4A_ Available in 1.2 meter model (4') only.





Carbon Filter

- Nanocarb™ activated carbon filter removes odors



ULPA Filter

- 10x Filtration efficiency of HEPA filter
- Yields 10x cleaner lab air from allergen than industry standard HEPA filter

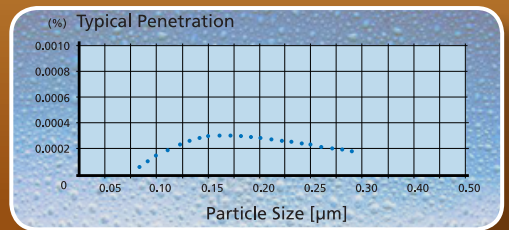

ELISA Proven Containment

- Provides >99% Allergen Containment.
- Ensures User's Safety.



7

ISOCIDE™ Powder Coat

- Silver-ion impregnated powder coat
- Inhibit microbial growth to improve safety

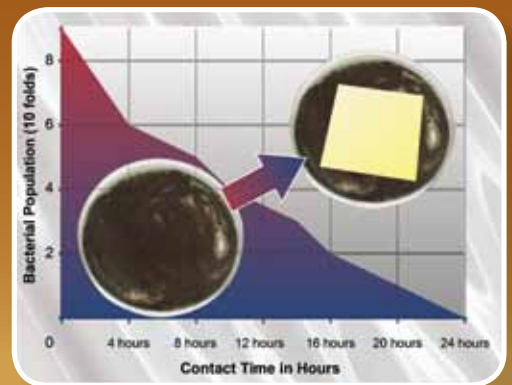

| Standards Compliance | Filtration | Electrical Safety |
|----------------------|---|-------------------|
| | EN-1822 (H14), Europe IEST-RP-CC001.3, USA IEST-RP-CC007, USA IEST-RP-CC034.1, USA | UL61010-1, USA |

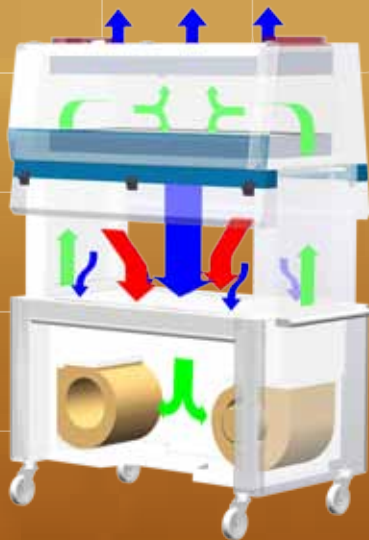

VDA Cabinet Airflow System

- The VDA Dual Access Workstation employs recirculating airflow configuration for better filtration efficiency.
- The blower system pulls ambient intake air through the front grilles, creating inflow that provides operator protection from allergen inside the work zone. An activated carbon pre-filter removes odors.
- Air flows through the common plenum on top of the cabinet. A portion of it goes up through ULPA filter as exhaust to create inflow. The remaining portion goes down through ULPA supply filter and bathes the work zone in clean air with a non-turbulent downflow.

- ULPA-filtered air
- Unfiltered / Potentially contaminated air
- Room air / Inflow air

- The combination of vertical laminar downflow and inflow creates an air curtain to protect the operator from contaminants released from the work surface.

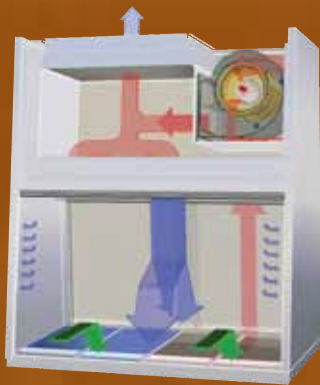

VA2 Cabinet Airflow System

- Ambient air pulled through the perforations towards the work zone front prevents contamination of the work surface and work product. The inflow does not mix with the clean air within the cabinet work zone. Inflow air travels through a return path toward the common air plenum (blower plenum) at the top of the cabinet.
- Approximately 40% of the air in the common plenum is exhausted through the ULPA filter to the room. The remaining 60% of the air is passed through the downflow ULPA filter and into the work area as a vertical laminar flow air stream bathing the work surface in clean air.

- ULPA-filtered air
- Unfiltered / Potentially contaminated air
- Room air / Inflow air

- The uniform, non-turbulent air stream protects against cross-contamination within and throughout the work area.
- Near the work surface, the ULPA-filtered downflow air stream splits with a portion moving toward the front air grille, and the remainder moving to the rear air grille. A small portion of the downflow enters the side capture zones at a higher velocity (small blue arrows).
- A combination of inflow and downflow air streams form an air barrier that prevents contaminated room air from entering the work zone, and prevents work surface emissions from escaping the work zone.

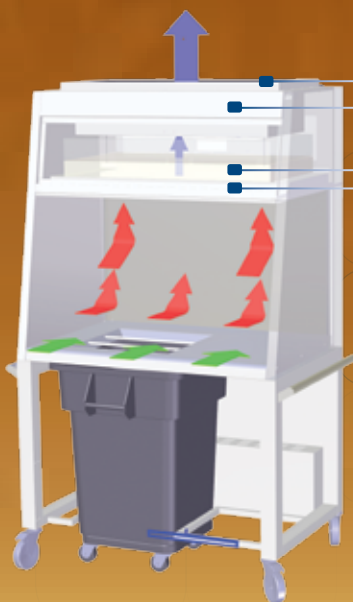

VBD Cabinet Airflow System

- Carbon Filter
- Blower
- Exhaust ULPA Filter
- Pre-Filter

- Room air is drawn in across the front of the cabinet with an average velocity of 0.35 m/s (70 fpm).
- Air is drawn up through the cabinet's work zone and forced through the ULPA filter (>99.999% typical efficiency for 0.1 to 0.3 micron sized particles).

- ULPA-filtered air
- Unfiltered / Potentially contaminated air
- Room air / Inflow air

- The full work zone ceiling extraction system ensures airflow uniformity throughout the cabinet's main chamber.
- The ULPA filtered air then returns to the laboratory stripped of all airborne contaminants and odor.



General Specifications, VIVA® Dual Access Animal Containment Workstation, Model VDA

| Model | VDA-4A_ | VDA-5A_ |
|--|--|--|
| External Dimensions (W x D x H) | 1340 x 762 x 1961 mm (52.8" x 30.0" x 77.2") min height 1340 x 762 x 2245 mm (52.8" x 30.0" x 88.4") max height | 1645 x 762 x 1961 mm (64.7" x 30.0" x 77.2") min height 1645 x 762 x 2245 mm (64.7" x 30.0" x 88.4") max height |
| Internal Work Area (W x D x H) | 1100 x 465 x 564 mm (43.3" x 18.3" x 22.2") | 1405 x 465 x 564 mm (55.3" x 18.3" x 22.2") |
| Downflow Velocity | 0.24 m/s (47 fpm) | |
| Pre-Filter | Disposable and non-washable polyester fibres with 85% arrestence / EU3 rated | |
| ULPA Filter Typical Efficiency | >99.999% for particle size between 0.1 to 0.3 microns, per IEST-RP-CC001.3 | |
| Sound Emission per EN 12469* | 53 dBA | 54 dBA |
| Fluorescent Lamp Intensity at Zero Ambient | 1725 lux (160 foot candles) | 1525 lux (142 foot candles) |
| Construction, Main Body | 1.5 mm (0.06") 16 gauge EG Steel with Isocide™ Oven-Baked Epoxy-Polyester Powder Coated Finish | |
| Shipping Dimensions, Maximum (W x D x H) | 1720 x 820 x 2240 mm (67.7" x 32.2" x 88.1") | 2025 x 820 x 2240 mm (79.7" x 32.2" x 88.1") |
| Shipping Weight | 342 Kg (754 lbs) | 432 Kg (952 lbs) |
| Shipping Volume, Maximum | 3.16 m ³ (111.6 cu.ft.) | 3.72 m ³ (131.4 cu.ft.) |
| Electrical Rating | VDA-_A8 | 220-240 VAC, 50 / 60 Hz, 1Ø |
| | VDA-_A9 | 110-130 VAC, 50 / 60 Hz, 1Ø |
| Power Consumption | VDA-_A8 | 190 W |
| | VDA-_A9 | 210 W |
| Accessories | Foldable Side Tray (SS Shelf Kit) | VDA-001 5170257 |
| | Side Shield | VDA-004 5170562 |
| | Feed Hopper | VDA-006 5170594 |

* Noise as measured in open field / anechoic chamber.

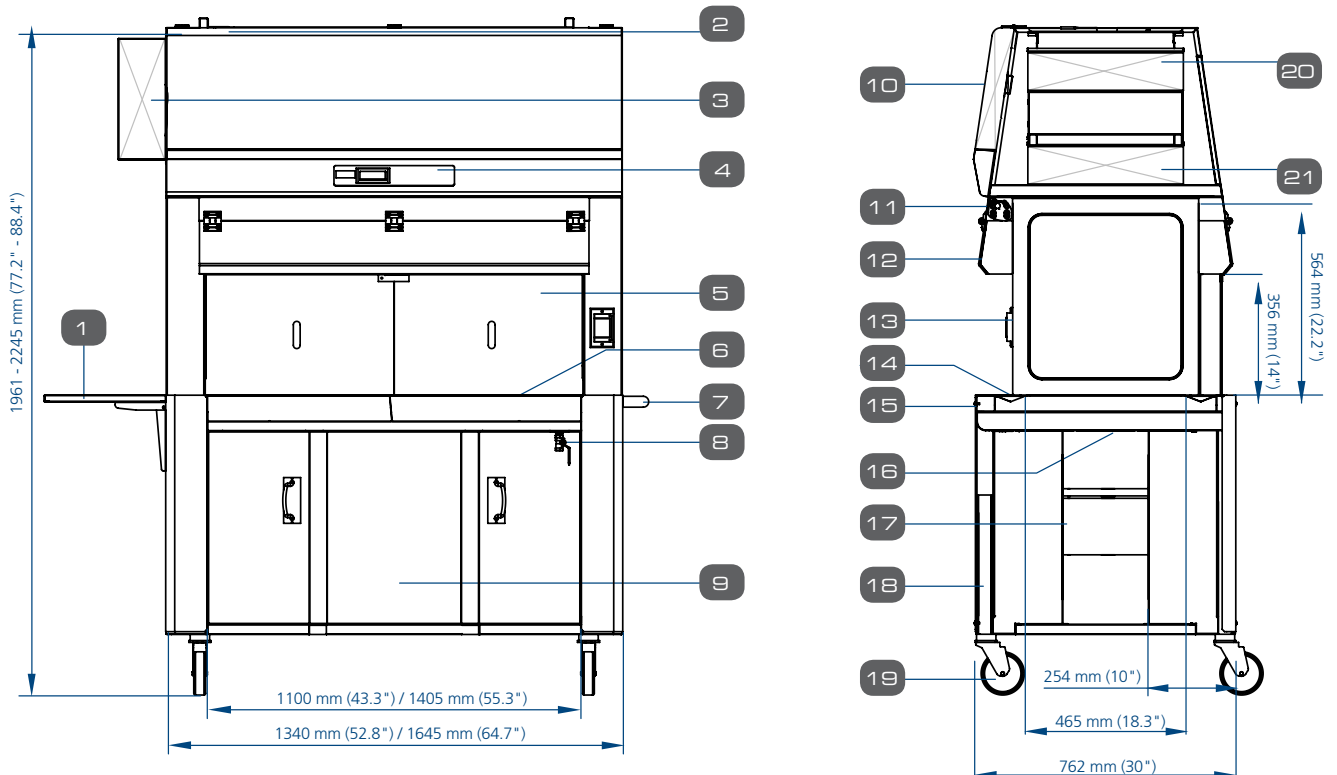

1. Foldable Side Tray
2. Airflow Sensor
3. Retractable Cord Reel (30 ft)
4. Sentinel™ Gold Microprocessor Control System
5. Optional Side Shield
6. Stainless Steel Work Top
7. Push Handle
8. Drain Valve

9. Knee Space (254 mm / 10" Deep) at both sides
10. Electrical Panel
11. T5 Fluorescent Lamps (1 on each side)
12. Hinged Polycarbonate Window
13. GFCI Electrical Outlets with Dip Proof Cover (1 on each right side)
14. Recessed Air Intake Grill
15. Arm Rest

16. Impregnated Activated Carbon Pre-filter
17. DC ECM Blower (Self-compensating and Low Noise)
18. Electric Hydraulic Height Adjustor
19. Caster Wheels
20. Exhaust ULPA/H14 Filter
21. Downflow ULPA/H14 Filter

ESCO

WORLD CLASS. WORLDWIDE.

General Specifications, VIVA® Universal Animal Containment Workstation, Model VA2

Note to customer: Insert electrical voltage number into last model number digit_when ordering.

| Model | VA2-4A_-E | | VA2-6A_-E | |
|--|---|--------------------------------------|---|--------------------------------------|
| Nominal Size | 1.2 meter (4') | | 1.8 meter (6') | |
| External Dimensions (W x D x H) | 1423 x 815 x 1510 mm (56" x 32.1" x 59.4") | | 2030 x 815 x 1510 mm (79.9" x 32.1" x 59.4") | |
| Maximum External Dimensions with Support Stand (W x D x H) | 1585 x 852 x 2235 mm (62.4" x 33.5" x 88.0") | | 2193 x 852 x 2235 mm (86.3" x 33.5" x 88.0") | |
| Internal Work Area (W x D x H) | 1270 x 623 x 680 mm (50.0" x 24.5" x 26.7") | | 1870 x 620 x 680 mm (73.6" x 24.4" x 26.7") | |
| Average Airflow Velocity | Inflow | 0.45 m/s (90 fpm) | | |
| | Downflow | 0.35 m/s (70 fpm) | | |
| Airflow Volume | Inflow | 625 m ³ / h (368 cfm) | 921 m ³ / h (542 cfm) | |
| | Downflow, 60% | 959 m ³ / h (547 cfm) | 1414 m ³ / h (832 cfm) | |
| | Exhaust, 40% | 625 m ³ / h (368 cfm) | 921 m ³ / h (542 cfm) | |
| ULPA Filter Typical Efficiency | >99.999% for particle size between 0.1 to 0.3 microns per IESTRP-CC001.3 | | | |
| Sound Emission* | NSF / ANSI 49 | 63 dBA | 64 dBA | |
| | EN 12469 | 60 dBA | 61 dBA | |
| Fluorescent Lamp Intensity | > 1400 lux (> 130 foot candles) | | > 1230 lux (> 114 foot candles) | |
| Cabinet Construction | 1.5 mm (16 gauge) electrogalvanized steel with Isocide white oven-baked epoxy power coating | | | |
| Net Weight Cabinet including stand | 406 Kg (895 lbs) | | 528 Kg (1164 lbs) | |
| Shipping Weight Cabinet including stand | 456 Kg (1005 lbs) | | 570 Kg (1257 lbs) | |
| Shipping Dimensions, Maximum (W x D x H) Cabinet excluding stand | 1550 x 950 x 1900 mm (61.0" x 37.4" x 74.8") | | 2150 x 950 x 1900 mm (84.6" x 37.4" x 74.8") | |
| Shipping Volume, excluding stand | 2.80 m ³ (99 cu.ft.) | | 3.88 m ³ (137 cu.ft.) | |
| Electrical* | Model | Voltage | Model | Voltage |
| | VA2-4A1-E | 220-240 VAC, 50/60 Hz, 1Ph, 5.5 amps | VA2-6A1-E | 220-240V, AC, 50/60 Hz, 1Ph, 6 amps |
| | VA2-4A2-E | 110-120 VAC, 50/60 Hz, 1Ph, 11 amps | VA2-6A2-E | 110-120V, AC, 50/60 Hz, 1Ph, 12 amps |

10

* Noise as measured in open field / anechoic chamber.

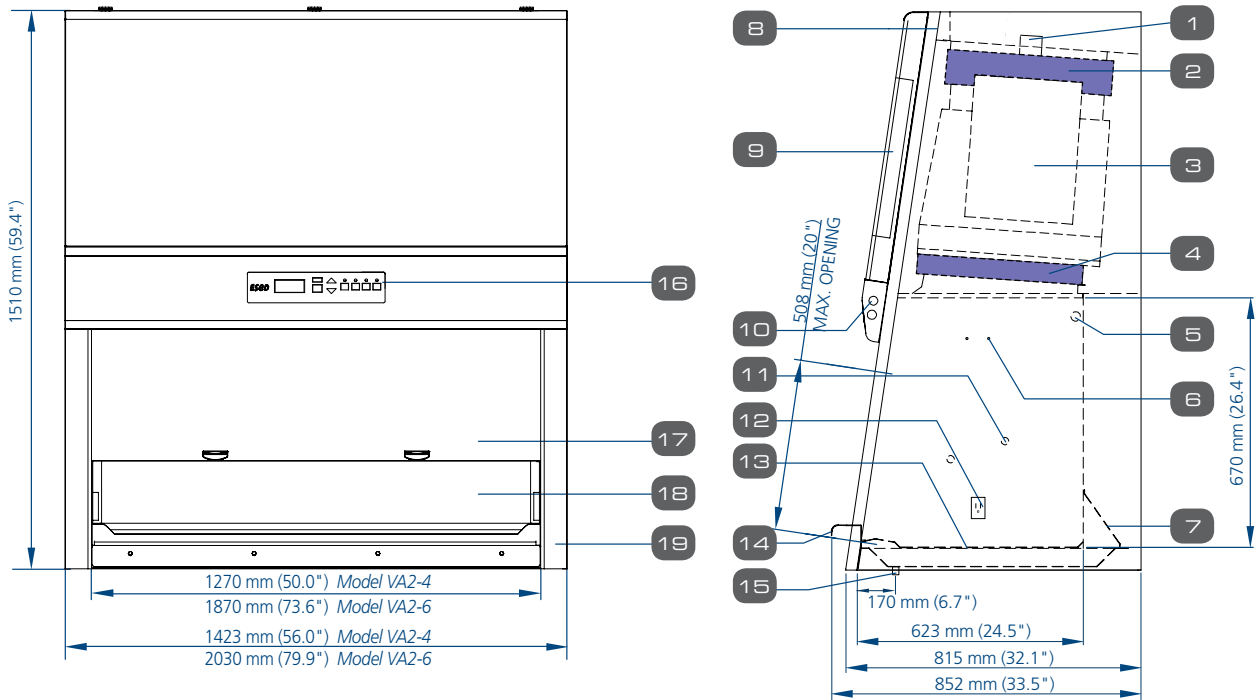

1. Airflow Sensor
2. Exhaust ULPA / H14 Filter
3. Energy-efficient DC ECM Blower
4. Downflow ULPA / H14 Filter
5. UV light Retrofit Kit Provision
6. IV bar Retrofit Kit Provision
7. Pre-filter

8. RS 232 Port, zero volt relay contacts for exhaust and alarm system
9. Electrical Panel
10. Fluorescent Lamps
11. Plugged Service Fixture provisions (2 on each side)
12. Electrical Outlet Retrofit Kit Provision
13. Stainless Steel Single-piece Work Tray

14. Stainless Steel Arm Rest
15. Drain Valve Retrofit Kit Provision
16. Sentinel™ Gold Microprocessor Control System
17. Safety Glass Sliding Sash Window
18. Single-piece Stainless Steel Back Wall and Side Walls
19. Removable Side Panel for plumbing access



General Specifications, VIVA® Bedding Disposal Workstation, Model VBD-4A_

| | | | | |
|--|------------------------------|--|------------------------|------------------------|
| Nominal Size | | 1.2 meter (4') | | |
| External Dimensions (W x D x H) | | 1247 x 760 x 1966 mm (49.1" x 30.0" x 77.4") minimum height 1247 x 760 x 2271 mm (49.1" x 30.0" x 89.4") maximum height | | |
| Internal Work Area (W x D x H) | | 1040 x 680 x 594 mm (40.9" x 26.8" x 23.4") | | |
| Work Surface Height | | 920 mm ~ 1225 mm (36.2" ~ 48.2") | | |
| Front Opening | | 400 mm (15.7") | | |
| Inflow Velocity | | 0.35 m/s (70 fpm) at initial setpoint | | |
| Pre-Filter | | Disposable, non-washable polyester fiber, 85% arrestance, EU3 rated | | |
| ULPA Filter Typical Efficiency | | >99.999% at 0.1 to 0.3 microns as per IEST-RP-CC001.3 USA | | |
| Sound Emission* Per EN 12469 | | 58 dBA | | |
| Fluorescent Lamps | | > 1,300 lux (> 121 foot candles) | | |
| Workstation Construction | Main Body | 1.2 mm (0.05") 18 gauge electro-galvanized steel with Isocide™ white oven-baked epoxy-polyester powder-coating | | |
| | Work Top | 1.2 mm (0.05") 18 gauge stainless steel, type 304, with 4B finish | | |
| | Inner Liner | 0.9 mm (0.035") 20 gauge stainless steel, type 304, with 4B finish | | |
| Net Weight | | 233 Kg (514 lbs) | | |
| Shipping Weight | | 294 Kg (648 lbs) | | |
| Shipping Dimensions, Maximum (W x D x H) | | 2150 x 1840 x 1230 mm (84.6" x 72.4" x 48.4") | | |
| Shipping Volume, Maximum | | 4.87 m³ (172 cu.ft.) | | |
| Electrical** | Model | VBD-4A1 | VBD-4A2 | VBD-4A3 |
| | Voltages | 220-240 VAC, 50 Hz, 1Φ | 110-120 VAC, 60 Hz, 1Φ | 220-240 VAC, 60 Hz, 1Φ |
| | Cabinet Full Load Amps (FLA) | 3 A | 6.5 A | 3 A |
| | Optional Outlets FLA | 5 A | 5 A | 5 A |
| | Cabinet Nominal Power | 309 W | 268 W | 309 W |
| | Cabinet BTU | 1054 | 914 | 1054 |

* Noise as measured in open field / anechoic chamber.

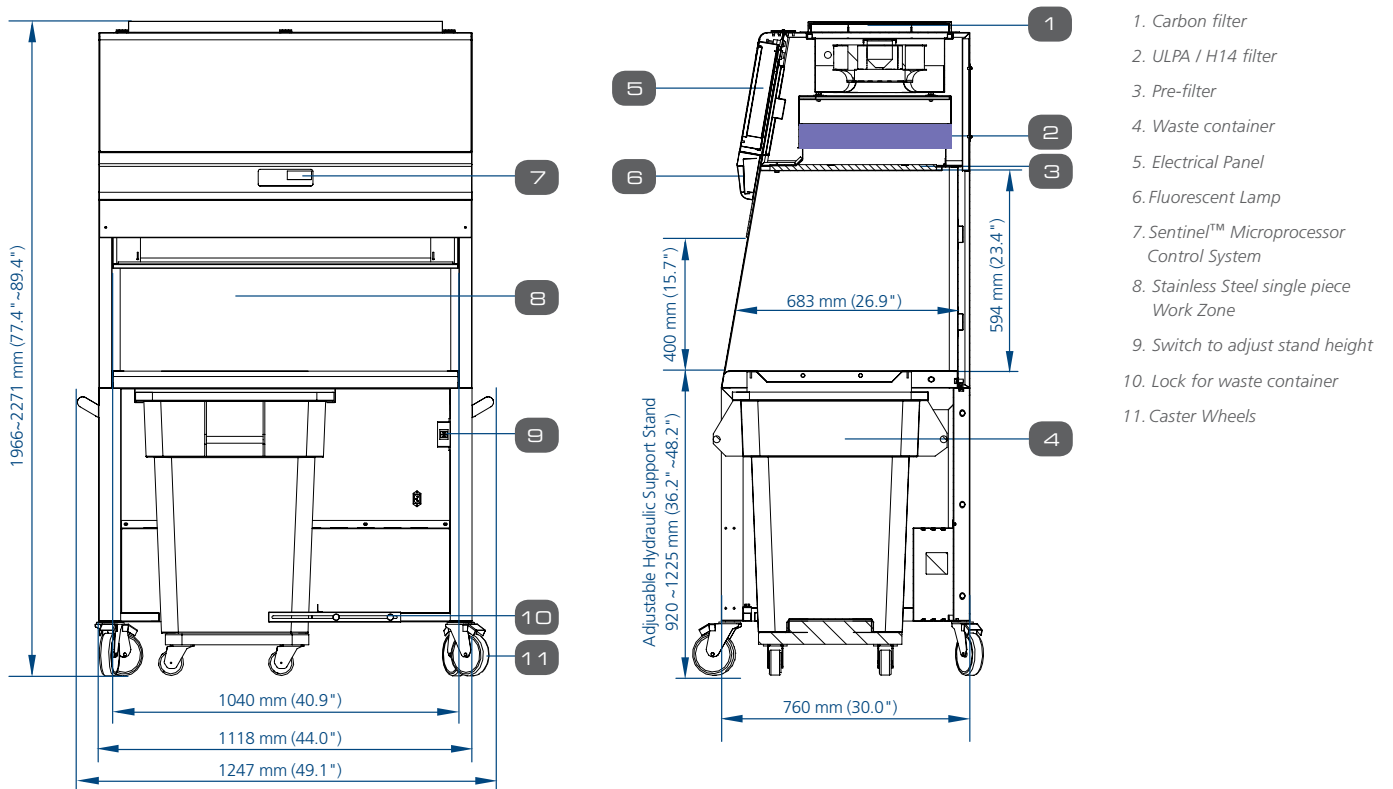

ESCO GLOBAL NETWORK

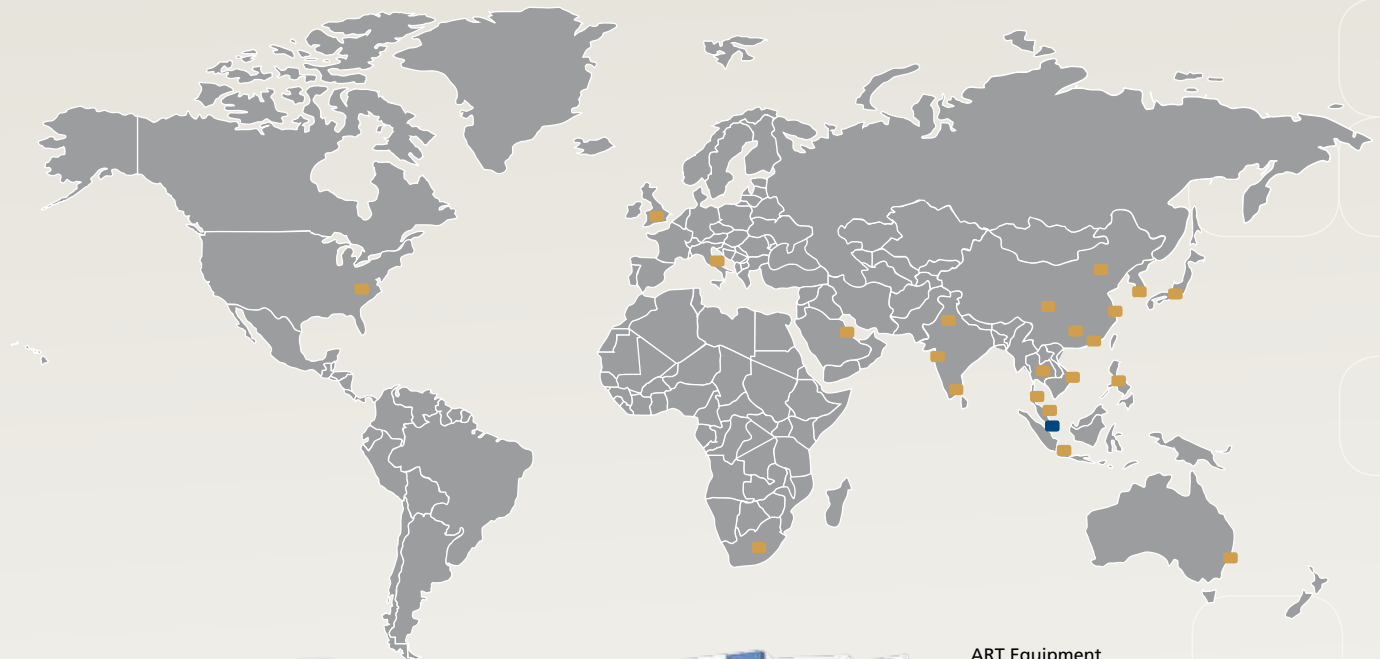

- ART Equipment
- Biological Safety Cabinets
- CO₂ Incubators
- Compounding Pharmacy Equipment
- Containment / Pharma Products
- Ductless Fume Hoods
- Freeze Dryer
- Lab Animal Research Products
- Laboratory Fume Hoods
- Laboratory Ovens and Incubators
- Laminar Flow Clean Benches
- PCR Cabinets
- PCR Thermal Cyclers
- Powder Weighing Balance Enclosures
- Ultra-low Freezers

The Esco Group of Companies is a global life sciences tools provider with sales in over 100 countries. The group is active in lab equipment, pharma equipment and medical devices. Manufacturing facilities are located in Asia and Europe. R&D is conducted worldwide spanning the US, Europe and Asia. Sales, service and marketing subsidiaries are located in 12 major markets including the US, UK, Singapore, Japan, China and India. Regional distribution centers are located in the US, UK, and Singapore.

Life Science • Chemical Research • Assisted Reproductive Technology (ART) • Pharmaceutical Equipment • General Equipment

ESCO

WORLD CLASS. WORLDWIDE.

Esco Micro Pte. Ltd. • 21 Changi South Street 1 • Singapore 486 777
 Tel +65 6542 0833 • Fax +65 6542 6920 • mail@escoglobal.com
 www.escoglobal.com

Esco Technologies, Inc. • 903 Sheehy Drive, Suite F, Horsham, PA 19044, USA
 Toll-Free USA and Canada 1-877-479-3726 • Tel 215-441-9661 • Fax 484-698-7757
 eti.sales@escoglobal.com • www.escolifesciences.us

Esco Global Offices: Bahrain | Bangladesh | China | India | Indonesia | Italy | Japan | Malaysia
 Philippines | Russia | Singapore | South Africa | South Korea | Thailand | United Kingdom | USA | Vietnam