



Lovibond[®] Colour Measurement Tintometer[®] Group



**Understanding
Colour Communication**

www.lovibondcolour.com

A Guide to Understanding Colour Communication

Contents	Page
What is Colour?	1
Communication of Colour	1
How to Describe Colour	2
Hue	
Chroma	
Lightness	
Ways to Measure Colour	3
Reflected Light	4
Spherical	
0°:45° (or 45°:0°)	
Multi-Angle	
Non-Contact	
Tristimulus Colorimeter	
Transmitted Light	7
Regular	
Diffuse	
Visual Comparators vs. Automatic Measurements	8
Colour Consistency	9
Accuracy of Measurements	10

Correct Record Keeping	11
-------------------------------	-----------

The Supply Chain	11
-------------------------	-----------

Methods of Quantifying Colour – Colour Scales and Spaces	12
---	-----------

- Lovibond® RYBN Colour
- Neutral Filters
- Colour Nomenclature
- The Munsell Scale
- CIE Colour Systems
- CIE XYZ
- Expressing Colour Uniformly
- CIELAB (L*a*b*)
- CIELAB (L*C*h)

Metamerism	18
-------------------	-----------

Colour Differences, Notation and Tolerancing	19
---	-----------

- Delta CIELAB (L*a*b*) and CIELAB (L*C*h)
- Delta (Δ) E* colour difference
- CIE Colour Space Notation
- Visual Colour and Tolerancing
- Delta E* Tolerancing
- CIELAB (L*a*b*) Tolerancing
- CIELAB (L*C*h) Tolerancing
- CMC Tolerancing
- CIE94 Tolerancing
- CIE2000 Tolerancing
- Choosing the Right Tolerance

Colour Scales	24
----------------------	-----------

- ASTM Colour (ASTM D 1500, ASTM D 6045, ISO 2049, IP196)
- EBC (European Brewing Convention)
- European Pharmacopoeia (EP) Colour
- Gardner Colour (ASTM D 1544, ASTM D 6166, AOCS Td 1a, MS 817 Part 10)
- Platinum-Cobalt/Hazen/APHA Colour (ASTM D 1209)
- Saybolt Colour (ASTM D 156, ASTM 6045)
- White and Yellow Indices

What is Colour?

Colour is a visual, perceptual property in human beings.

Colour derives from the spectrum of light (distribution of light energy versus wavelength) interacting in the eye with light sensitive cells. In our environment, materials are coloured depending on the wavelengths of light they reflect or transmit.

The visible colour spectrum runs from red through to blue wavelengths, approximately 360-720nm.

Three things are necessary to see colour:

- A light source
- An object
- An observer/processor

Communication of Colour

How would you describe the colour of this rose? Would you say it's yellow, lemon yellow or maybe a bright canary yellow?

Each person verbally describes and hence defines an object's colour differently.

As a result, objectively communicating a particular colour to someone without some type of physical standard is difficult. Describing the precise colour difference in words between two objects is very challenging.

Your perceptions and interpretations of colour and colour comparisons are highly subjective. Eye fatigue, age and other physiological factors can influence your colour perception.

But even without such physical considerations, each observer interprets colour based on their personal perspective, feelings, beliefs and desires. For example you may convince yourself that a certain colour match is within tolerance if you are under pressure to declare a colour match as acceptable.

The solution to this dilemma is an instrument that explicitly identifies a colour by measuring it and comparing the colour to standards completely objectively and accurately each and every time. That is, an instrument that differentiates a colour from all others and assigns it a numeric value.

Before we measure a colour we need to establish a means of describing it.



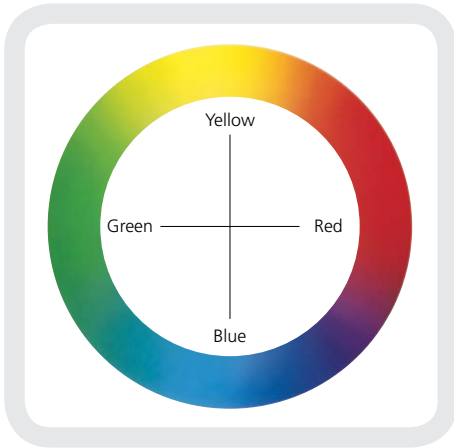

Figure 1: Hue

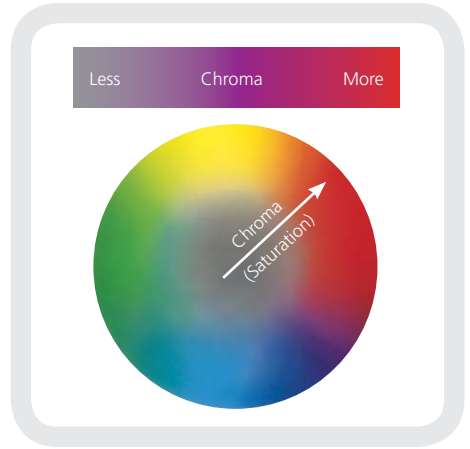

Figure 2: Chromaticity

How to describe Colour?

Colour is typically described utilising three elements: hue, chroma and value (lightness). By describing a colour using these three attributes, you can accurately identify a particular colour and distinguish it from any other.

Hue

When asked to identify the colour of an object, you'll most likely speak first of its hue. Quite simply, hue is how we perceive an object's colour — red, orange, green, blue, etc.

The colour wheel in Figure 1 shows the continuum of colour from one hue to the next. As the wheel illustrates, if you were to mix blue and green paints, you would get blue-green. Add yellow to green for yellow-green, and so on.

Chroma

Chroma describes the vividness or dullness of a colour — in other words, how close the colour is to either grey or the pure hue. For example, think of the appearance of a tomato and a radish. The red of the tomato is vivid, while the radish appears duller.

Figure 2 shows how chroma changes as we move from the centre to the perimeter. Colours in the centre are grey (dull) and become more saturated (vivid) as we move toward the perimeter. Chroma also is known as saturation.

Lightness

The luminous intensity of a colour — i.e., its degree of lightness — is called its value. Colours can be classified as light or dark when comparing their value.

For example, when a tomato and a radish are placed side by side, the red of the tomato appears to be much lighter. In contrast, the radish has a darker red value. In Figure 3, the value, or lightness, characteristic is represented on the vertical axis.

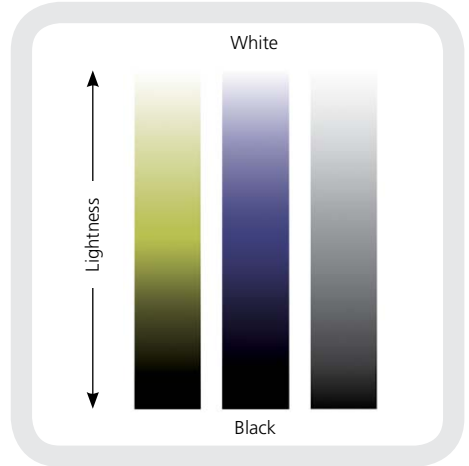

Figure 3: Lightness

Ways to Measure Colour

Today, Colorimeters, Spectrophotometers and Spectrophotometric Colorimeters are the most commonly used instruments for measuring colour worldwide.

These technologies measure the proportion of reflected or transmitted light at many points on the visual spectrum. The points can be plotted graphically to form a spectral curve. Since the spectral curve of each colour is completely unique, like a signature or fingerprint, the curve is an excellent tool for identifying, specifying and matching colour.

When an object interacts with light, some of the wavelengths of light are absorbed and others are reflected or transmitted (in the case of a coloured but clear liquid). Therefore a red ball absorbs all wavelengths of light except for those in the red part of the spectrum, which it reflects.

A blue ball reflects only blue wavelengths. A glass of apple juice transmits green and yellow wavelengths. Fresh snow reflects most of the light that interacts with it and hence appears white. Black is the absence of reflected light.

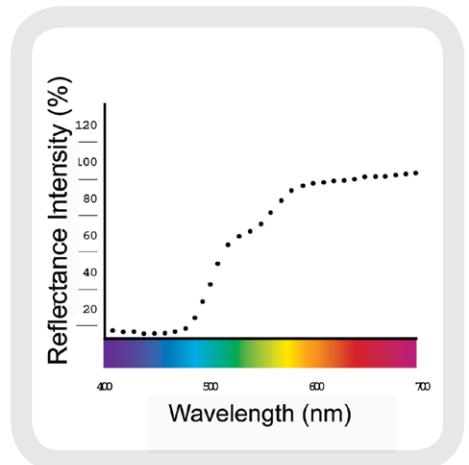

Figure 4: Spectral curve from a measured sample

Due to the numerous potential applications for colour measurement and the wide range of different types of materials which need to be tested, there are many diverse instrumental options which have been optimised for specific purpose.

The first consideration is whether the colour being measured is from light reflecting off a sample or light being transmitted through a sample.

Reflected Light

Reflected light can be measured in a number of different ways: different instrument geometries affect the reading obtained but can be easily matched to your application.

The different instrument geometries do, however, share common elements. Light from a controlled light source and a sensitive light detector are always utilised.

Spherical

Spherically based instruments have played a major role in colour quality control systems for nearly 50 years. The 'sphere' refers to the sphere which has a highly reflective inner surface and a circular aperture, against which the sample is placed to allow colour measurement. Inside the sphere are a light source and a detector. Spheres have two alternative geometric configurations for the relative arrangement of the light source and the detector. Specular Component Included (SCI) and Specular Component Excluded (SCE).

The Specular Component, also commonly known as Gloss, is the component of light that is reflected from a surface at an angle equal to the incidence angle of the

illumination. A high Gloss surface will reflect more light into the Specular direction (i.e. act as a mirror) and appear smooth and shiny. A low Gloss surface will reflect less light and appear matt.

The light that is not reflected in a Specular direction, but scattered in many directions, is called Diffuse reflectance.

If two samples of identically coloured plastic, that differ only in surface effect (i.e. one shiny, the other matt), are measured using the same instrument in SCI and SCE modes, the results will differ as follows.

In SCE mode, the Specular reflectance is excluded from the measurement and only the diffuse reflectance is measured. This produces a colour evaluation which correlates to the way the observer sees the colour of an object.

When using the SCI mode, the Specular reflectance is included with the diffuse reflectance during the measurement process. This type of colour evaluation measures total appearance independent of surface conditions.

Therefore the two samples of plastic should provide values that are very similar when measured in the SCI mode and values that show a colour difference in the SCE mode. The difference between the two indicates the effect of gloss on appearance.

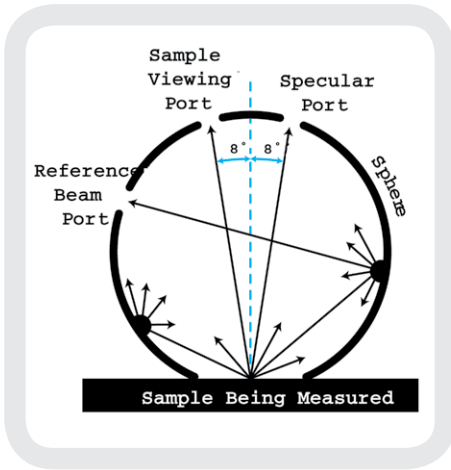

Sphere

Most sphere based instruments use an angle close to the perpendicular, usually 8° , to give the capability of including or excluding the Specular reflectance while measuring. By opening a small port in the sphere, the Specular component is excluded from the measurement. This is because light that would be reflected at an equal angle (on the opposite side of the perpendicular) to the sample viewing port is lost when the Specular port is open. Therefore it is not included in any measurement. In some instruments the same effect can be achieved by using optics as opposed to an open port.

$0^\circ:45^\circ$ (or $45^\circ:0^\circ$)

The angles in this type of instrument refer to the relative angles of the detector and illuminating light source in the instrument. (The first angle is the angle of the light source, and the second is the angle of the detector – a 0° angle being perpendicular to the surface of the sample being measured).

The detector positioned can be at a single point in a plane at a 45° angle, or a number of detectors can be positioned at a number of discrete points around a circumference to approximate an annular ring.

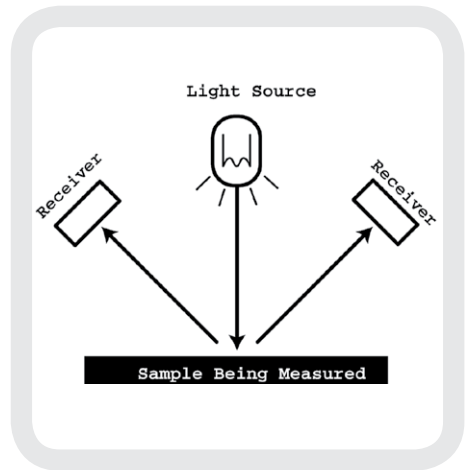

$0^\circ / 45^\circ$

No instrument “sees” colour more like the human eye than the $0^\circ:45^\circ$. This is simply because a viewer does everything in his or her power to exclude the Specular Component or Specular Reflectance (gloss) when judging colour. When we look at pictures in a glossy magazine, we arrange ourselves so that the gloss does not reflect back to the eye.

A 0°:45° instrument will remove gloss from the measurement and measure the appearance of the sample as the human eye would see it.

Multi-Angle

In the past 20 years or so, car makers have experimented with special effect colours. They use special additives such as mica, pearlescent materials, ground-up seashells, microscopically coated coloured pigments and interference pigments to produce different colours at different angles of view.

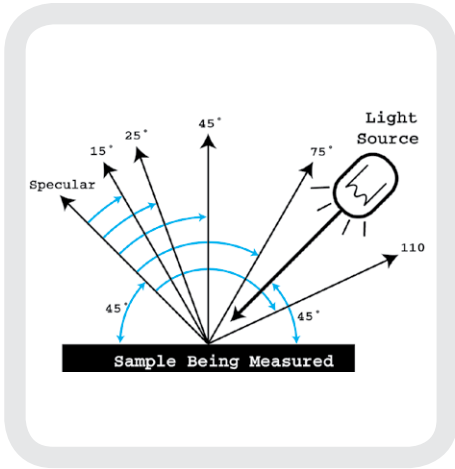

Multi-angle

Large and expensive Goniometers were traditionally used to measure these colours until battery-powered, hand-held, multi-angle instruments were introduced. Portable multi-angle instruments are now used by most auto makers and their supply chains worldwide.

Non-Contact

Products that normally require protection from physical contact with measurement apertures, such as liquids and pastes, or in which the surface appearance is changed by the presentation method, such as when the sample is pressed behind glass, can now be measured in their natural, unaltered state, as the eye sees the sample by using non-contact colour measurement technology.

Non Contact geometry spectrophotometers are designed for the colour measurement of many types of wet and dry samples including powders, pastes, gels, plastics and paints.



NC45

Tristimulus Colorimeter

Colorimeters are not the same as spectrophotometers. They are tristimulus (three-filtered) devices that make use of red, green and blue filters that emulate the response of the human eye to light and colour.

Transmitted Light

Transmitted light can be measured by focussing light from a controlled light source through the sample and then analysing the light that passes through and falls upon the detector.

Regular

This is the most common transmittance geometry where the sample is placed into a parallel beam of light between the light source and the measurement system.

For meaningful results, the sample should give a pin sharp image when looking through it at other objects. Any level of turbidity will seriously interfere with the accuracy of readings of colour using regular transmitted light.

Diffuse

This geometry uses a sphere. Either the sample is illuminated by a parallel beam of light with a sphere to collect the light transmitted through the sample or the sphere is used to illuminate the sample diffusely with measurement of the light coming perpendicularly through the sample.

This is the way translucent samples and those that scatter light, giving a cloudy or fuzzy image of objects viewed through them, should be measured. For example; fruit juice is frequently measured using this method.



PFXI

Visual Comparators vs. Automatic Measurements

Ensuring colour accuracy every time is critical to producing products of a consistent, high quality.

Reliable and repeatable colour test results are the key to ensuring final product quality and also to minimise production costs. Simplicity of operation helps to reduce error and increase productivity.

The fundamental difference between the Lovibond® Visual and Automatic ranges is that the Visual instruments are based on subjective, visual comparison methods (relying to a high degree on the judgment and skill of the operator and hence their perspective, feelings, beliefs, and desires) while the Automatic ranges rely on automatic, non-subjective measurements (and are hence completely unaffected by the judgment of the operator.)

With operators inexperienced in this area, visual comparison can be more time consuming and less precise than the fast automatic readings. Visual agreement between different operators at one site or multiple sites cannot be guaranteed.

The skill/experience of operators, degree of acceptable error, sample preparation time, scale choice and required scale resolution should be carefully considered before making a decision on which instrument to purchase.

Visual systems are of a lower initial cost but their limitations should be taken into account when selecting the correct instrument.



Comparator 2000

Colour Consistency

When comparing Visual (subjective) to Automatic (non-subjective) colour assessment, the fundamental differences between these methods need to be considered.

Basic steps can be taken to reduce colour communication problems:

- Do you have a systematic, consistent and reliable means of sample preparation and presentation?

For example: When measuring liquids are you using comparable, clean, cells?

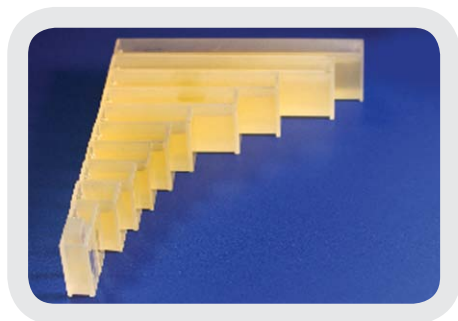

Image 1 – Top View

Image 1 shows the same liquid sample viewed across a range of cell path lengths. Image 2 shows that, as path length changes, the perceived colour of the samples will change significantly. Any visual or automatic methods' results would be influenced by this difference.

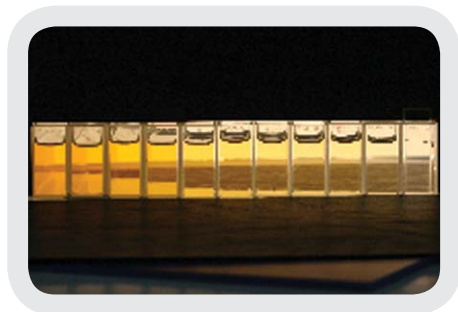

Image 2 – Front View

For example, with **Lovibond® RYBN Colour**, it is advisable that the depth of colour should never be greater than that which may be matched by a total of 20 Lovibond® units. This is because slight differences are most easily perceived in intensities ranging between approximately 3 and 10 units of the predominating colour. To clarify:

(i) using a 5.25" cell, a sample gives **R** 1.7, **Y** 8, **B** 0 and **N** 0.1 = 9.8 in total, the path length used is correct.

(ii) using a 5.25" cell a sample gives **R** 5.7, **Y** 31, **B** 0 and **N** 0.1 = 36.8 in total, the path length used is therefore incorrect since the Y is high. A 1" cell should be considered.

The choice of path length will impact accuracy. Unless working to a particular specification, the optical path length of the cell used should be related to the colour intensity of the sample.

When comparing with others, it is necessary to check that cell path length and type (Optical Glass, Borosilicate or Plastic) are identical and the cells used are clean and undamaged.

- Confirm the correct colour scale is selected on the Automatic instrument? With CIE $L^*a^*b^*$, other settings such as light source and degree observer (10° or 2°) also need to be defined and communicated.

Historically a number of scales are available that report Red & Yellow values. This is a common source of error. For example; a standard Model F reports Lovibond® Red, Yellow, Blue and Neutral units (RYBN). An AF710 reports AOCS Tintometer® in terms of Red & Yellow (RY). An Automatic instrument may be configured to display both RYBN and RY.

Accuracy of Measurements

For peace of mind in production and quality control, it is crucial that the correct performance of instruments can easily be confirmed.

There are different options available:

1) Liquid Reference Standards:

High quality liquid samples with known values are used to check that an instrument is reporting the correct figures. The range of Lovibond® colour reference standards includes AOCs-Tintometer®, ASTM, Gardner, Lovibond® RYBN, Pt-Co/Hazen/ APHA and Saybolt Colour. Each standard is shipped with a 12-month guarantee of colour stability.

2) Glass Filters: Conformance filter sets allow quick and simple conformance checks on Lovibond® instruments. Each filter set is supplied with a Certificate of Conformity that confirms that they have been manufactured under the control of an ISO 9001: 2000 Quality Management System.

3) Solid Reference Standards:

High quality physical standards with known values are used to check that a Lovibond® instrument is reporting the correct figures.

Web based solutions are becoming increasingly popular. They allow remote testing and calibration of automatic instruments using conformance standards.

Reference liquid standards and conformance filters are assigned a nominal value and Lovibond Tintometer always endeavours to match this value as closely as possible.

On occasion, it may not be possible to match the requested value exactly. The value achieved and the expected performance tolerances will, of course, always be reported.



Liquid Reference Samples

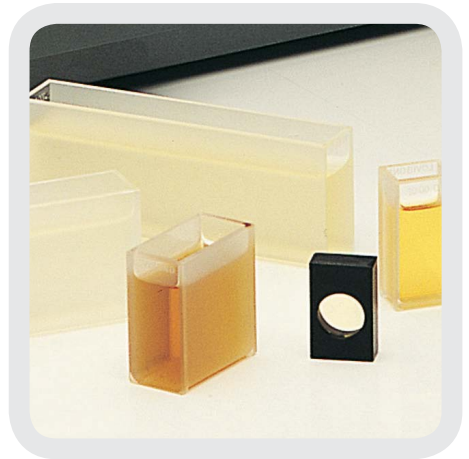

Glass Conformance Filters

Correct Record Keeping

Colour Consistency is simple to achieve if care is taken to eliminate possible causes of variation between instruments. Methods should be documented, circulated and complied with.

Ideally, the following information should be recorded for each colour measurement:

- Instrument model used
- Serial number (if multiple instruments are available)
- Date
- Time (if multiple samples are measured on the same day)
- Name of observer/operator
- Description of sample
- Sample reference number (if relevant)
- Temperature of sample if heated

- Any comments on condition of sample (e.g. turbid or dirty etc)
- Path length of optical cell
- Colour space or colour scale used
- Light source and degree observer (if using CIE systems)
- Individual colour values
- Any other information required by the organisation
- Any additional comments relevant to the colour match

Special care should be taken with regards to colour scales utilising Red and Yellow values to avoid miscommunication.

Instruments should be maintained correctly and regularly checked using 3rd party standards.

The Supply Chain

Defining the colour of a product and ensuring colour accuracy every time is critical to long-term success and accurate communication within a supply chain.

The clear and correct description of colour standards and tolerances is critical when:

- Specifying materials when sourcing
- Communicating colour within the wider supply chain
- Inspecting incoming materials
- Conducting continual production Quality Control
- Inspecting final/outgoing products
- Guaranteeing compliance with National & International Standards

Reliable and repeatable colour test results are the key to ensuring final product quality, and also to minimising production costs. Speed of analysis can also be vital for efficient process control. Simplicity of operation helps to reduce error and increase productivity.

Methods of Quantifying Colour – Colour Scales and Spaces

There are many different types of colour systems available. Some of them are applicable to any type of substance, whereas some are specific to opaque materials or transparent materials. The use of specific colour scales or spaces varies from one industry to another depending on standards and requirements.

Lovibond® RYBN Colour

The Lovibond® RYBN colour scale is optimised for the colour measurement of clear (but coloured) liquids. In the 1890's, Joseph Lovibond, the founder of The Tintometer Ltd, developed the original Lovibond® Scale, based on a calibrated series of red, yellow, blue and neutral glasses.

The Lovibond® Scale is based on 84 calibrated glass colour standards of different

densities of magenta (red), yellow, blue and neutral glasses, graduating from de-saturated to fully saturated. Sample colours are matched by a suitable combination of the three primary colours together with neutral filters, resulting in a set of Lovibond® RYBN units that define the colour.

Since several million combinations are available, it is possible to match the colour of almost any sample. It is particularly popular for measuring the colour of oils and fats, chemicals, pharmaceuticals and syrups. After more than a century, The Tintometer Ltd still manufactures and grades the glass filters used for visual colour measurement in terms of Lovibond® units. It is this unparalleled knowledge and experience that has enabled the company to accurately replicate the scale in its automatic instruments.



Model F with Racks

The scale quoted by others as the Lovibond® scale does not guarantee validated Lovibond® Colour readings and may not conform to any visual instrument for Lovibond® Colour.

Neutral Filters

If, for any reason, an operator alters the method of use or changes any convention, it is important that they should give details when recording results, otherwise confusion could ensue. For example, observers employ neutral filters to dull a bright sample but omit to report the fact. In other cases they endeavour to make the best possible match without stating neutral values although they were needed, or use different colours in combination only in a fixed ratio according to some arbitrary convention.

Colour Nomenclature

The Lovibond® Scale provides its own simple language of colour which can fully describe the appearance of any colour in the least possible number of words and figures to avoid language difficulties. For convenience of laboratory records, or in communicating readings between laboratories, many industries record their results on a three colour basis, quoting the Red, Yellow and Blue instrumental values.

Some industries find it more convenient to simplify these terms by using the six divisions of the spectrum.

Red

Orange – combination of red and yellow.

Yellow

Green – combination of yellow and blue.

Blue

Violet – combination of red and blue.

These six terms are used in combination with “bright” and “dull”.

A sample is described as being bright when the nearest possible match appears dull in comparison. When this occurs, neutral values are introduced and recorded as sample brightness.

A sample is described as being dull when red, yellow and blue are required to make a match. The value of the colour which is least is expressed as dullness.

The Munsell Scale

In 1905, artist Albert H. Munsell originated a colour ordering system – or colour scale – which is still used today. The Munsell System of Colour Notation is significant from a historical perspective because it is based on human perception. Moreover, it was devised before instrumentation was available for measuring and specifying colour. The Munsell System assigns numerical values to the three properties of colour: hue, value and chroma. Adjacent colour samples represent equal intervals of visual perception.

The model in Figure 5 depicts the Munsell Colour Tree, which provides physical samples for judging visual colour. Today's colour systems rely on instruments that utilise mathematics to help us judge colour.

As noted earlier, there are three things necessary to see colour:

- A light source (also known as the illuminant)
- An object (also known as the sample)
- An observer/processor

CIE Colour Systems

The CIE, or Commission Internationale de l'Éclairage (translated as the International Commission on Illumination), is the body responsible for international recommendations for photometry and colorimetry. In 1931, the CIE first standardised colour order systems by specifying the light source (or illuminants), the observer and the methodology used to derive values for describing colour. As time has passed they have been updated and added to.

The CIE Colour Systems utilise three coordinates to locate a colour in a 'colour space'. These colour spaces include

- CIE XYZ,
- CIE L*a*b*
- CIE L*C*h.

Colours can be quantified using these colour spaces by different calculations based upon specification of light source type and defining 'standardised' observers (these two parameters are accounted for using different mathematical formulae).

Instruments quantify colour by gathering and filtering the wavelengths of light transmitted through, or reflected from, an object. The instrument perceives the different intensities of different light wavelengths and these intensity values are recorded as points across the visible spectrum spectral data. Spectral data is represented as a spectral curve. This curve is the colour's fingerprint (Figure 6).



Figure 5: The Munsell Colour Tree

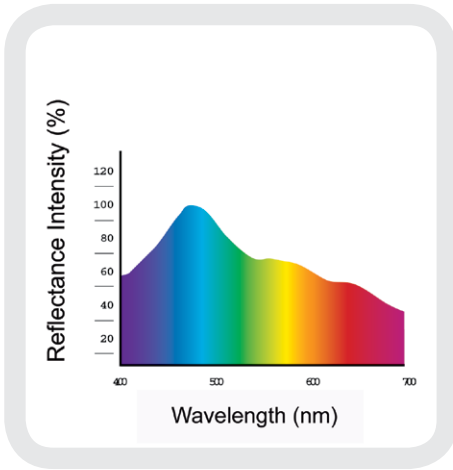

Figure 6: Daylight (standard illuminant D65)

Once we obtain a colour’s transmittance or reflectance curve, we can apply mathematics to map the colour onto a colour space.

To do this, we take the reflectance curve and multiply the data by a CIE standard illuminant and other illuminant. The illuminant is a graphical representation of the light source under which the samples are viewed. Each light source has an energy distribution that affects how we see colour. Examples of different illuminants are A – incandescent, D65 – daylight (Figure 6) and F2 – fluorescent.

We multiply the result of this calculation by a CIE standard observer. The CIE commissioned work in 1931 and 1964 to derive the concept of a standard observer, which is based on the average human response to wavelengths of light (Figure 7). In short, a standard observer represents how an average person sees colour across the visible spectrum when using a defined

area of the eyes’ retina. These values can now be used to identify a colour numerically.

CIE XYZ

The three co-ordinates required to define a colour in the CIE XYZ colour space are known as the Tristimulus values (XYZ). These are calculated using the standard illuminant, the sample’s spectral curve and also a standard observer. Unfortunately Tristimulus values have limited use as colour specifications because they correlate poorly with visual attributes. While Y relates to value (lightness), X and Z do not correlate to any visual attributes.

As a result, when the 1931 CIE standard observer was established, the commission designed the chromaticity coordinates xy which can be correlated to chroma and hue. These are derived from XYZ. The coordinate’s xy are used to form the chromaticity diagram in Figure 9. The notation Yxy specifies colours by identifying lightness (Y) and the colour as viewed in the chromaticity diagram (x,y).

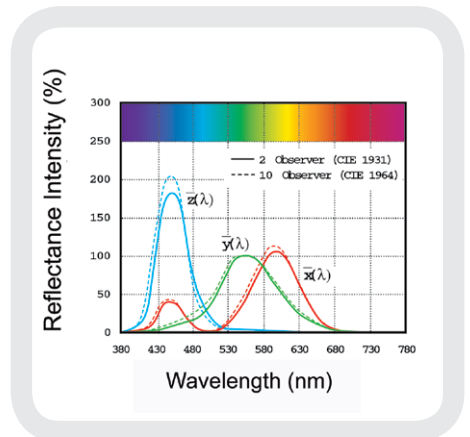

Figure 7: CIE 2° and 10° Standard Observers

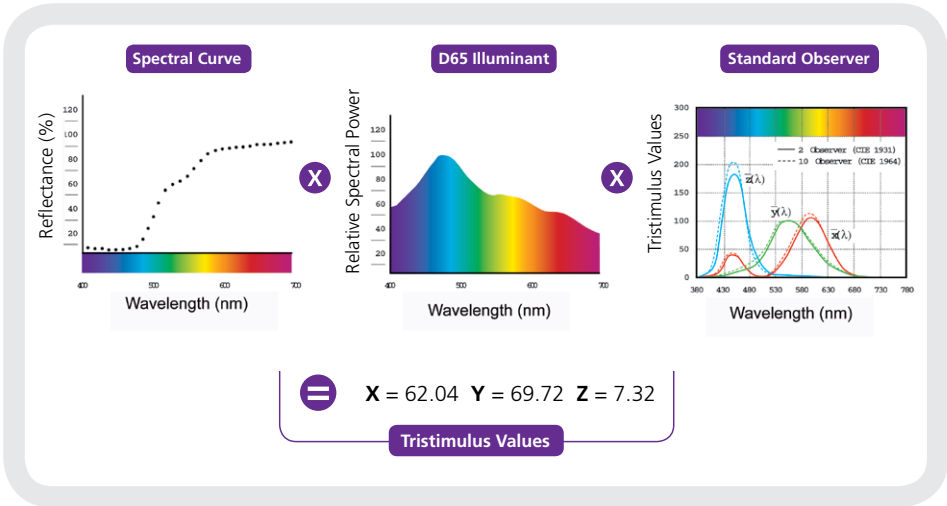

Figure 8: Tristimulus Values

As Figure 10 shows, hue is represented at all points around the perimeter of the chromaticity diagram. Chroma, or saturation, is represented by a movement from the central white (neutral) area out toward the diagram's perimeter, where 100% saturation equals pure hue.

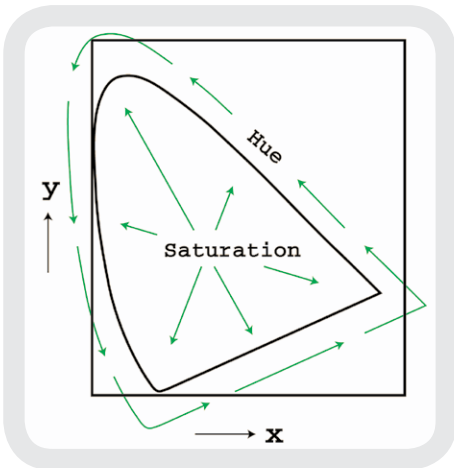

Figure 10: Chromaticity diagram

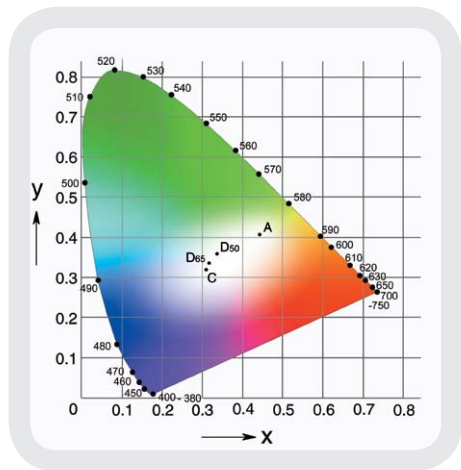

Figure 9: CIE 1931 (x,y) chromaticity diagram

Expressing Colour Uniformly

One issue with the (x,y) chromaticity diagram is that the different colours are not uniformly distributed. In an attempt to solve this problem, the CIE recommended two alternate, uniform colour scales: CIE 1976 ($L^*a^*b^*$) or CIELAB, and CIE 1976 ($L^*u^*v^*$) or CIELUV.

These colour scales are based on the opponent-colours theory of colour vision, which says that two colours cannot be both green and red at the same time, nor blue and yellow at the same time.

As a result, single values can be used to describe the red/green and the yellow/blue attributes.

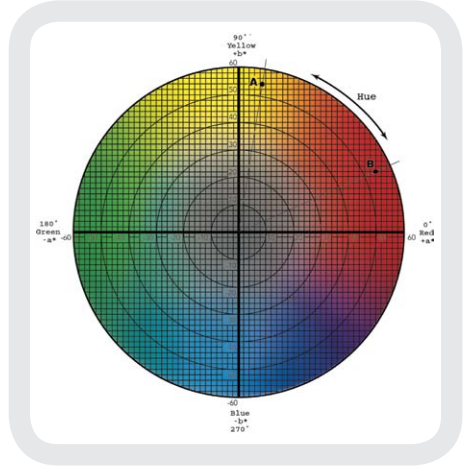
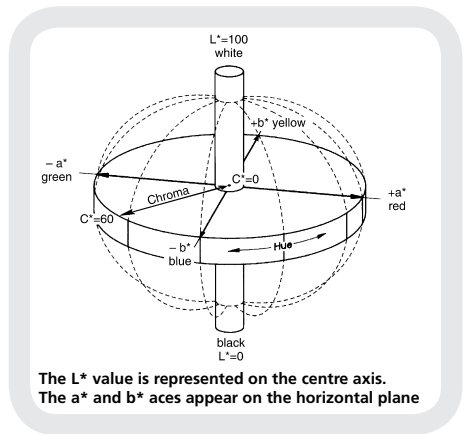

Figure 11: CIELAB colour chart

CIELAB ($L^*a^*b^*$)

When a colour is expressed in CIELAB, L^* defines lightness, a^* denotes the red/green value and b^* the yellow/blue value.

Figures 11 and 12 show the colour-plotting diagrams for $L^*a^*b^*$. The a^* axis runs from left to right. A colour measurement movement in the $+a$ direction depicts a shift toward red. Along the b^* axis, $+b$ movement represents a shift toward yellow. The centre L^* axis shows $L = 0$ (black or total absorption) at the bottom and $L = 100$ or white at the top. In between are greys. All colours on this axis can be considered as neutrals as they are not coloured in any particular direction. To demonstrate how the $L^*a^*b^*$ values represent the specific colours of Flowers A and B, we've plotted their values on the CIELAB Colour Chart in Figure 11.



The L^* value is represented on the centre axis. The a^* and b^* axes appear on the horizontal plane

Figure 12

The a^* and b^* values for Flowers A and B intersect at colour spaces identified respectively as points A and B (see Figure 11). These points specify each flower's hue (colour) and chroma (vividness/dullness).

When their L^* values (degree of lightness) are added in Figure 12, the final colour of each flower is obtained.

CIELAB (L^*C^*h)

While CIELAB ($L^*a^*b^*$) uses Cartesian coordinates to calculate a colour in a colour space, CIELAB (L^*C^*h) uses polar coordinates. This colour expression can be derived from CIELAB ($L^*a^*b^*$). The L^* , as before defines lightness, C^* specifies chroma and h denotes hue angle, an angular measurement.

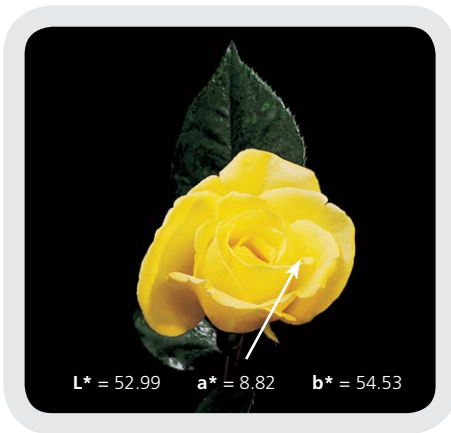

Flower A



Flower B

Metamerism

Coloured materials can sometimes exhibit **metamerism**. A phenomenon exhibited by a pair of colours that match under one or more

sets of illuminants, but not under all illuminants. It is therefore advisable to match colours under a Primary, Secondary and Tertiary illuminant.

Colour Differences, Notation and Tolerancing

Delta CIELAB (L*a*b*) and CIELAB (L*C*h)

Assessment of colour is often more than a numeric expression. Usually it is an assessment of the colour difference (delta) of a sample relative to a known standard. CIELAB (L*a*b*) and CIELAB (L*C*h) are used to compare the colours of two objects.

The expressions for these colour differences are ΔL^* , Δa^* , Δb^* , or ΔL^* ΔC^* ΔH^* (Δ symbolises "delta," which indicates difference). Given ΔL^* , Δa^* and Δb^* , or ΔL^* , ΔC^* and ΔH^* , the total difference or distance on the CIELAB diagram can be stated as a single value, known as ΔE^* .

Delta (Δ) E* colour difference

$$\Delta E^*_{ab} = [(\Delta L^*)^2 + (\Delta a^*)^2 + (\Delta b^*)^2]^{1/2}$$

$$\Delta E^*_{ab} = [(\Delta L^*)^2 + (\Delta C^*)^2 + (\Delta H^*)^2]^{1/2}$$

Let us compare the colour of Flower A to Flower C. Separately, each would be classified as a yellow rose. But what is their relationship when set side by side? How do the colours differ?

Using the equation for ΔL^* , Δa^* , Δb^* , the colour difference between Flower A and Flower C can be expressed as:

$$\Delta L^* = +11.10$$

$$\Delta a^* = -6.10$$

$$\Delta b^* = -5.25$$

The total colour difference can be expressed as $\Delta E^* = 13.71$

The values for Flowers A and C are shown at the bottom of this page. On the a^* axis, a reading of -6.10 indicates greener or less red. On the b^* axis, a reading of -5.25 indicates bluer or less yellow. On the L^* plane, the measurement difference of $+11.10$ shows that Flower C is lighter than Flower A.

If the same two flowers were compared using CIELAB (L*C*h), the colour differences would be expressed as:

$$\Delta L^* = +11.10$$

$$\Delta C^* = -5.88$$

$$\Delta H^* = 5.49$$

Referring again to the flowers shown below, the ΔC^* value of -5.88 indicates that Flower C is less chromatic, or less saturated. The ΔH^* value of 5.49 indicates that Flower C is greener in hue than Flower A. The ΔL^* and ΔL^* values are identical for CIELAB (L*C*h) and CIELAB (L*a*b*).

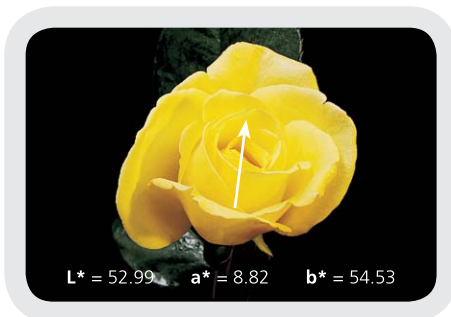

Flower A



Flower C

CIE Colour Space Notation

ΔL^* = difference in lightness/darkness value
(+ve = lighter, -ve = darker)

Δa^* = difference on red/green axis
(+ve = redder, -ve = greener)

Δb^* = difference on yellow/blue axis
(+ve = yellower, -ve = bluer)

ΔC^* = difference in chroma
(+ve = brighter, -ve = duller)

ΔH^* = difference in hue

ΔE^* = total colour difference value

Refer to Figure 11 for visualisation.

Visual Colour and Tolerancing

Tolerances for an acceptable colour match typically consist of a three-dimensional boundary with varying limits for lightness, hue and chroma, and must agree with visual assessment. CIELAB can be used to create those boundaries. The simplest method to create a spherical tolerance is Delta E* tolerancing. Additional tolerancing formulas, known as CMC and CIE94, produce ellipsoidal tolerances.

Delta E* Tolerancing

Delta E* is the total colour difference computed with a colour difference equation:

$$\Delta E^*_{ab} = [(\Delta L^*)^2 + (\Delta a^*)^2 + (\Delta b^*)^2]^{1/2}$$

$$\Delta E^*_{ab} = [(\Delta L^*)^2 + (\Delta C^*)^2 + (\Delta H^*)^2]^{1/2}$$

It is used widely as a single value method of identifying if a colour is within or outside a tolerance – ie an acceptable Pass or Fail. Delta E* should not be confused with ΔE CMC or other single value tolerancing techniques.

CIELAB (L*a*b*) Tolerancing

When tolerancing with L*a*b*, you may choose a difference limit for ΔL^* (lightness), Δa^* (red/green), and Δb^* (yellow/blue). These limits create a tolerance cuboid box around the standard (Figure 14).

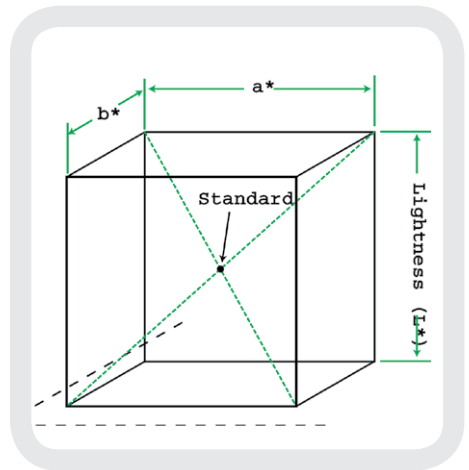

Figure 14: CIELAB tolerance box

When comparing this tolerance box with a ellipsoid/sphere tolerance, some problems emerge. A box-shaped tolerance around the ellipsoid/sphere can give good numbers for unacceptable colour (Figure 15). If the tolerance box is made small enough to fit within the ellipsoid/sphere, it is possible to get bad numbers for visually acceptable colour.

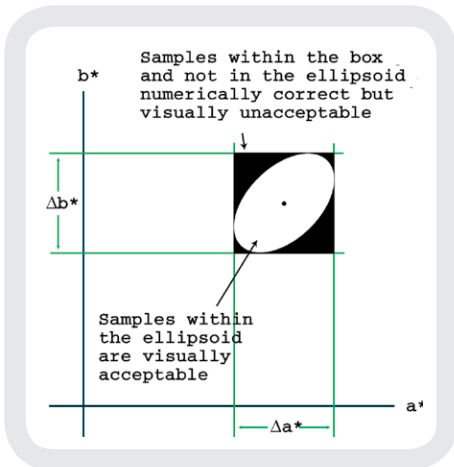

Figure 15: Numerically correct vs. Visually acceptable

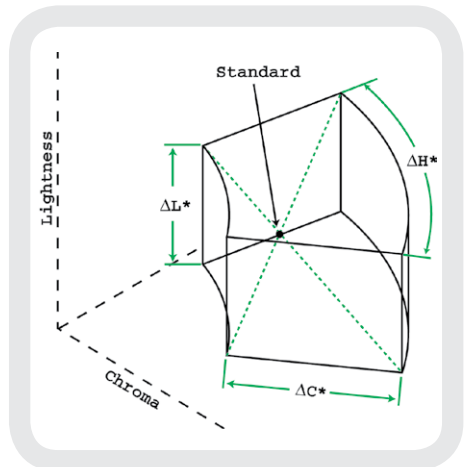

Figure 16: CIELAB (L^*C^*h) tolerance wedge

CIELAB (L^*C^*h) Tolerancing

CIELAB (L^*C^*h) users must choose a difference limit for ΔL^* (lightness), ΔC^* (chroma) and ΔH^* (hue). This creates a wedge-shaped box around the standard. Since CIELAB (L^*C^*h) is a polar-coordinate system, the tolerance box can be rotated in orientation to the hue angle (Figure 16).

When this tolerance is compared with the ellipsoid, we can see that it more closely matches human perception. This reduces the amount of disagreement between the observer and the instrumental values (Figure 17).

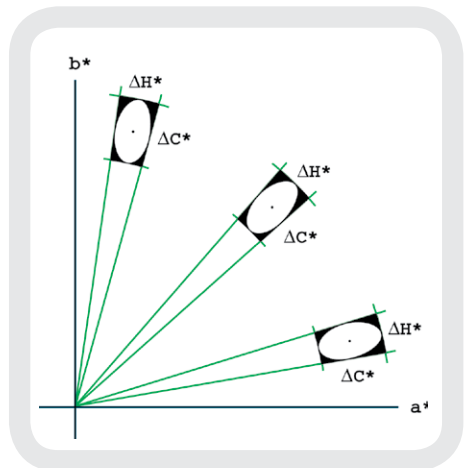

Figure 17: CIELAB (L^*C^*h) tolerance ellipsoids

CMC Tolerancing

As the eye does not detect differences in hue (red, yellow, green, blue, etc.), chroma (saturation) or lightness equally, the average observer will have variable sensitivity to hue, chroma and lightness differences (the order of sensitivity in hue is greater than chroma

which is greater than lightness). Because of this, visual acceptability is best represented by an ellipsoid (Figure 18).

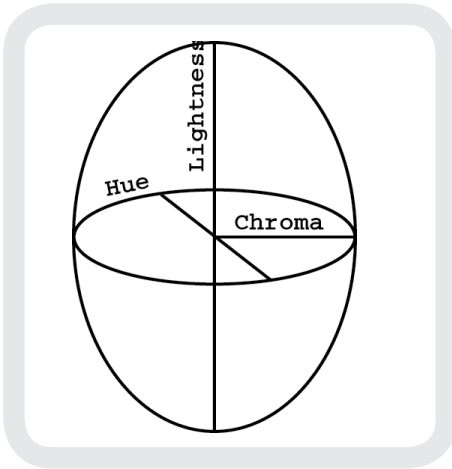

Figure 18: Tolerance Ellipsoid

CMC is not a colour space but rather a tolerancing system. CMC tolerancing is based on CIELAB (L^*C^*h) and provides better agreement between visual assessment and measured colour difference. CMC tolerancing was developed by the Colour Measurement Committee of the Society of Dyers and Colourists in Great Britain and became public domain in 1988.

The CMC calculation mathematically defines an ellipsoid around the standard colour with semi-axis corresponding to hue, chroma and lightness. The ellipsoid represents the volume of acceptable colour and automatically varies in size and shape depending on the position of the colour in colour space.

Figure 19 shows the variation of the ellipsoids throughout colour space. The ellipsoids in the orange area of colour space are longer and narrower than the broader and rounder ones in the green area. The size and shape of the ellipsoids also change as the colour varies in chroma and/or lightness.

The CMC equation allows you to vary the overall size of the ellipsoid to better match what is visually acceptable. By varying the commercial factor (cf), the ellipsoid can be made as large or small as necessary to match visual assessment. The cf value is the tolerance, which means that if $cf=1.0$, then ΔE CMC less than 1.0 would pass, but more than 1.0 would fail (see Figure 20, *top of the next page*).

Since the eye will generally accept larger differences in lightness (l) than in chroma (c), a default ratio for (l:c) is 2:1. A 2:1 ratio will allow twice as much difference in lightness as in chroma. The CMC equation allows this ratio to be adjusted to achieve better agreement with visual assessment.

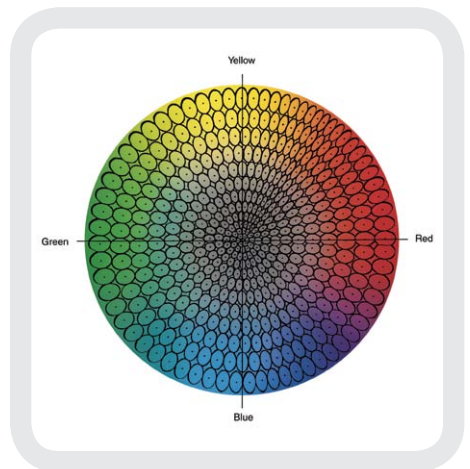

Figure 19: Tolerance ellipsoids in colour space

- Tolerance ellipsoids are tightly packed in the orange region
- Tolerance ellipsoids are larger in the green area

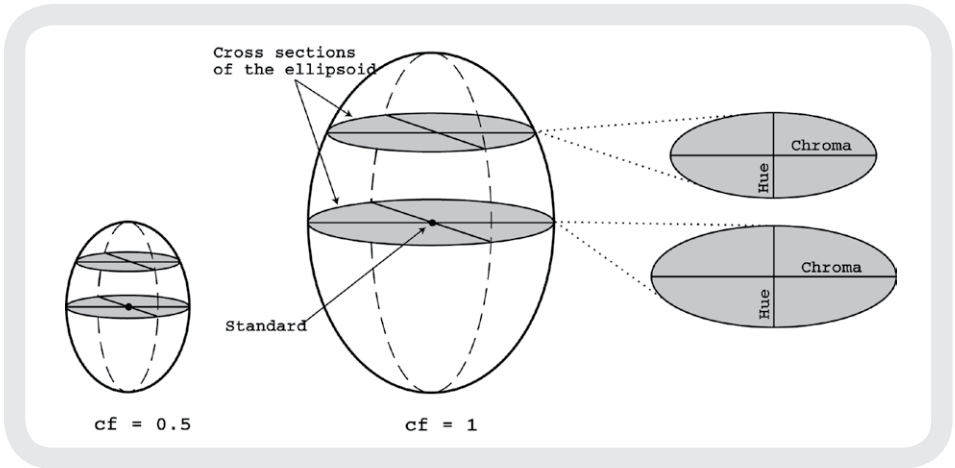

Figure 20: Commercial Factor (CF) of tolerances

CIE94 Tolerancing

In 1994 the CIE released a new tolerance method called CIE94. Like CMC, the CIE94 tolerancing method also produces an ellipsoid. The user has control of the lightness (kL) to chroma (KC) ratio, as well as the commercial factor (cf). These settings affect the size and shape of the ellipsoid in a manner similar to how the l:c and cf settings affect CMC.

However, while CMC is targeted for use in the textile industry, CIE94 is targeted for use in the paint and coatings industry. You should consider the type of surface being measured when choosing between these two tolerances. If the surface is textured or irregular, CMC may be the best fit. If the surface is smooth and regular, CIE94 may be the best choice.

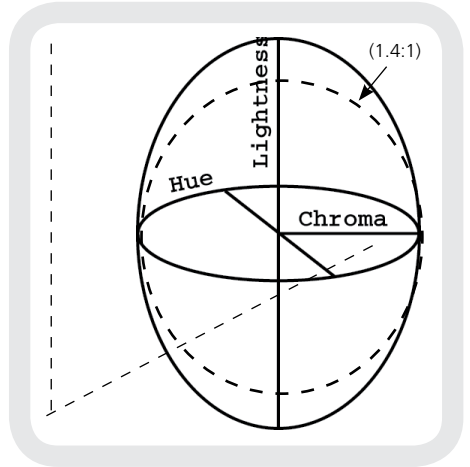

Figure 21: CMC Tolerance Ellipsoids

CIE2000 Tolerancing

Since the 1994 definition did not adequately resolve the perceptual uniformity issue, the CIE refined their definition, adding some corrections.

Choosing the Right Tolerance

When deciding which colour difference calculation to use, consider these five rules;

1. Select a single method of calculation and use it consistently.
2. Always specify exactly how the calculations are made.
3. Never attempt to convert between colour differences calculated by different equations through the use of average factors.
4. Use calculated colour differences only as a first approximation in setting tolerances, until they can be confirmed by visual judgments.
5. Always remember that nobody accepts or rejects colour because of numbers – it is the way it looks that counts.

Colour Scales

Although the CIE colour notation systems can be used for any of the endless list of colour control applications, it is often simpler to use an industry specific colour scale for routine grading of many types of material.

Grading techniques are widely used to assess product colour by comparison with a representative series of fixed colour standards. For many product types, a characteristic set of standards was agreed and adopted to aid colour control and the communication of colour specifications; the result is a selection of traditional colour grading scales that have been adopted as industry standards and are still in common use today.

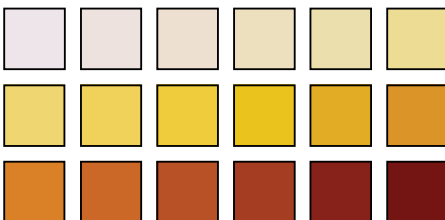

Example Colour Scale

The following Scales are examples of those currently most widely used by industry. Please note: when measuring liquids, cell path length is critical as the same material measured in different path length cells will appear a different colour.

A specific path length of cell must be stated for accurate colour communication. The measurement standards issued for some colour scales require specific path length cells. More details and the latest information can be found within the Scales Section at www.lovibondcolour.com

ASTM Colour (ASTM D 1500, ASTM D 6045, ISO 2049, IP 196)

The ASTM Colour Scale is widely utilised for the grading of petroleum products such as lubricating oils, heating oils and diesel fuel oils.

Mineral oils are constantly checked for colour during processing in order to establish when they have been refined to the required grade. Colour is also used as a means of confirming that the correct oil or fuel is being used for its intended use and that no contamination or degradation of quality has occurred.

ASTM D1500 is a single number, one dimensional, colour scale ranging from a pale straw through to a deep red in sixteen steps (0.5 - 8.0 units in increments of 0.5 units). Visual Comparators can achieve a resolution of 0.5 units, Automatic instruments can achieve a resolution of 0.1. To comply with specifications, a 33mm path length must be used. ASTM D1500 superseded the 12-step D155 NPA (National Petroleum Association) scale in 1960.

Other petroleum products that do not fall within the scope of ASTM D1500, such as undyed gasoline, white spirit, petroleum wax and kerosene, may be graded using the Saybolt test ASTM D156 or IP (Institute of Petroleum) 17.

EBC (European Brewing Convention)

The EBC colour scale, developed by the Institute of Brewing and the European Brewing Convention, is a recognised method for colour grading of beers, malts and caramel solutions as well as similarly coloured liquids. It has a range of 2 to 27 visual units; yellower pale worts and lagers at the low end of the scale and the amber of dark worts, beers and caramels at the upper end of the scale.

If the sample falls outside this range (e.g. concentrates, syrups) then sample dilution

and/or a different path length cell can be used to bring the reading within the EBC range.

European Pharmacopoeia (EP) Colour

The EP Colour Standards were originally visual colour standards intended to improve colour communication between sites by defining a sample colour as being close to a physical liquid standard ("near EP Y2") rather than using the words "light yellow".

EP consists of 3 primary colour standard solutions (yellow, red, blue) that are combined with hydrochloric acid to make 5 standard solutions that, when further diluted with hydrochloric acid (10 mg/l), make 37 reference EP standards; Red (R1 - R7); Yellow (Y1 - Y7); Brown (B1 - B9); Brown/Yellow (BY1 - BY7); Green/Yellow (GY1 - GY7).

Automatic instruments can now measure the EP Colour. Measurements are based on specific wavelengths for each of the various pharmacopoeia colour scales (US and Chinese Pharmacopoeia are local alternatives).

Gardner Colour (ASTM D 1544, ASTM D 6166, AOCS Td 1a, MS 817 Part 10)

The Gardner Colour scale as specified in ASTM D1544 is a single number, one dimensional, colour scale for grading the colour of similarly coloured liquids such as resins, varnishes, lacquers, drying oils, fatty acids, lecithins, sunflower oil and linseed oil.

The scale ranges from a pale yellow to a red in shade and is described in terms of the values 1-18. The glass standards used with

the comparator can achieve a resolution of 1 unit. Automatic instruments can achieve a resolution of 0.1. To comply with specifications, a 10mm path length must be used.

The light yellow Gardner colour numbers (1 to 8) are based on potassium chloroplatinate solutions, numbers 9 to 18 on solutions of ferric chloride, cobaltous chloride and hydrochloric acid.

In 1958, The Tintometer Ltd was instrumental in the development of the master glass standards that were utilised when the current Gardner scale was specified in 1963; the earlier 1933 and 1953 versions are available upon request in the form of Comparator 2000 discs.

Platinum-Cobalt/Hazen/APHA Colour (ASTM D 1209)

This scale is often referred to as Pt-Co, Platinum-Cobalt, Hazen or APHA Colour. All terms are interchangeable and equally valid. It is used to measure clear to dark amber liquids.

The scale was originally defined by specified dilutions of a platinum-cobalt stock solution, ranging from 0 at the light end of the scale to 500 at the darkest. The scale is now available in a digital format on Automatic instruments. The scale is used extensively in the water industry but also for clear oils, chemicals and petrochemicals such as glycerine, plasticisers, solvents, carbon tetrachloride and petroleum spirits.

Saybolt Colour (ASTM D 156, ASTM 6045)

The Saybolt Colour scale is used for grading light coloured petroleum products including aviation fuels, kerosene, naphthas, white

mineral oils, hydrocarbon solvents and petroleum waxes.

The colour range of the Saybolt-scale is similar to that of the Platinum-Cobalt/Hazen/APHA Colour (ASTM D 1209) scale and is therefore employed for the measurement of water-clear, colourless to slightly yellowish products. The faintest coloration is Saybolt-colour number +30, the strongest evaluable Saybolt coloration value is -16.

White and Yellow Indices

Certain industries, such as paint, textiles and paper manufacturing, evaluate their materials and products based on standards of whiteness. Typically, this whiteness index is a preference rating for how white a material should appear, be it photographic and printing paper or plastics.

Therefore Whiteness Index is a measurement which correlates the visual ratings of whiteness for certain white and near-white surfaces.

Yellowness Index is a number calculated from spectrophotometric data that describes the change in colour of a test sample from colourless through to yellow.

The American Standards Test Methods (ASTM) has defined whiteness and yellowness indices. The E313 whiteness index is used for measuring near-white, opaque materials such as paper, paint and plastic. In fact, this index can be used for any material whose colour appears white.

Notes

The Tintometer Ltd

Lovibond House / Solar Way
Solstice Park
Amesbury, SP4 7SZ
UNITED KINGDOM

Tel: +44 (0)1980 664800

Fax: +44 (0)1980 625412

Tintometer North America

6456 Parkland Drive
Sarasota
FL 34243
USA

Tel: +1 941-758-8671

Fax: +1 941-727-9654

Toll Free: 855-Color12 (855-265-6712)

Tintometer – South East Asia

Unit B-3-12, BBT One Boulevard,
Lebuh Batu Nilam 2, Bandar Bukit Tinggi,
Klang, 41200, Selangor D.E.
MALAYSIA

Tel: +603 3325 2286

Fax: +603 3325 2287

Tintometer – China

Room 1001, China Life Tower,
16 Chaoyangmenwai Avenue,
Beijing, 100020
CHINA

Tel: +86 10 85251111 ext.330

Fax: +86 10 85251001

sales@tintometer.com
www.lovibondcolour.com

Lovibond® & Tintometer® are Registered Trade Marks of The Tintometer Limited. All translations and transliterations of LOVIBOND® & TINTOMETER® are asserted as Trade Marks of The Tintometer Limited. Registered Office: Lovibond House, UK.

Registered in England No. 45024 –
Errors and Omissions Excepted –
Content subject to alterations without notice.
920173_V2_02/13