



Model: ADC_B/C/E_



Model: SPD-A_

Ascent™ Series

Ductless Fume Hoods

The Safe, Energy-Efficient Solution for Modern Chemistry

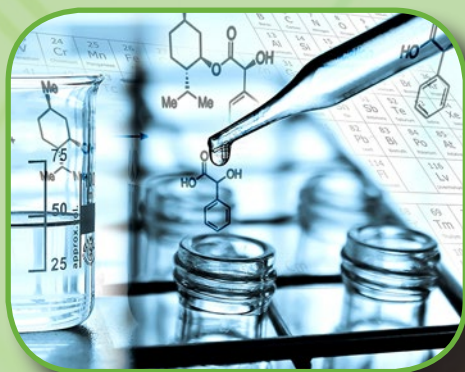

ESCO

WORLD CLASS. WORLDWIDE.

Ascent™ Series Ductless Fume Hoods

Table of Contents

Corporate Profile	3
Product Overview	4
Guide to choosing the right Ductless Fume Hood	6
Filtration System	8
Advantages of Esco Fume Hoods	9
Guide to Models	9
Ascent™ Opti Ductless Fume Hood	10
Ascent™ Opti Engineering Drawing	12
2 Ascent™ Opti General Specifications	13
Ascent™ Max Ductless Fume Hood	14
Ascent™ Max (B and D series) Engineering Drawing	16
Ascent™ Max (B and D series) General Specifications	17
Ascent™ Max (C series) Engineering Drawing	18
Ascent™ Max (C series) General Specifications	19
Ascent™ Max (E series) Engineering Drawing	20
Ascent™ Max (E series) General Specifications	21
Accessories and Options	22
Main Carbon Filter	23
Secondary Filter Options	24



Welcome to Esco

Esco's Vision is to provide enabling technologies for scientific discoveries to make human lives healthier and safer.

The Esco Lifesciences Group is committed to deliver innovative solutions for the clinical, life sciences, research, industrial, laboratory, pharmaceutical, and IVF community. With the most extensive product line in the industry, Esco have passed a number of international standards and certifications. Esco represents innovation and forward-thinking designs, that are of the highest standard quality since 1978.

Availability and Accessibility. Esco has headquarters in Singapore, Indonesia, and Philippines, with manufacturing facilities are located in Asia and Europe. Research and Development (R&D) is conducted worldwide spanning the US, Europe and Asia. Sales, services and marketing subsidiaries are located in 42 major markets including US, UK, Japan, China and India. Esco regional distribution centers are located in Singapore, Malaysia, Thailand, Vietnam, Myanmar, Indonesia, Philippines, Bangladesh, Hong Kong, Taiwan, South Korea, China, Japan, India, UAE, Central and South Africa, Denmark, Germany, Italy, Lithuania, Russia, United Kingdom, and USA. Because of our worldwide presence, you can be sure that Esco is within your reach.

High Quality, Reliable, and Dependable. Esco products are of high quality, reliable, and dependable; assuring customers of research accuracy. Cross functional teams from Esco Production, R&D, Quality Assurance, and Senior Management, are regularly assembled to review and implement areas for improvement.









Esco Cares for Your Safety. Esco focuses on providing safety not just for your samples but also for you and the environment.

Esco Cares for Your Comfort. Building ergonomic designs and reducing noise levels of the units ensures comfort for our users.

Esco Cares for the Environment. One in every four of Esco's employees is involved in R&D and a number of them evaluate new components and/or designs to produce energy efficient equipment. Being GREEN is more than just modifying parts used to produce a new energy efficient technology, it is also embodied in the every aspect of the company.

Customer Service and Support. Our service does not stop once purchase has been done. Esco gives on-time customer service and offers end-user seminars, service training, preventive maintenance, and provides educational materials and informative videos.

As Esco takes the opportunity to respond to the world's needs, we aim not only to contribute in the advancement of scientific discoveries but also in making the world a safer, healthier, and better place to live in.

- 
-  Global Offices
 -  Joint Ventures
 -  Licensee
 -  Distributors
 -  Factories
 -  R&D Centers
 -  Regional Distribution Centers

PRODUCT OVERVIEW



Ascent™ Opti Series Model: SPD-A

- Main Filter: Carbon Filter
- Double hinged sash mechanism
- Includes a mobile cart, no sink
- Available sizes: 3,4 ft



Ascent™ Opti Series Model: SPD-B

- Main Filter: Carbon Filter
- Double hinged sash mechanism
- Transparent back wall made of acrylic
- Includes a mobile cart, no sink
- Available sizes: 3,4 ft.



Ascent™ Max Series Model: ADC-B (Standard model)

- Main Filter: Carbon Filter
- Has an option for motorized sash
- Optional VOC sensor
- Available sizes: 2,3,4,5,6 ft.

Ascent™

Ductless Fume Hood • Ascent™ Max Ductless Fume Hoods and Ascent™ Opti Ductless Fume Hoods

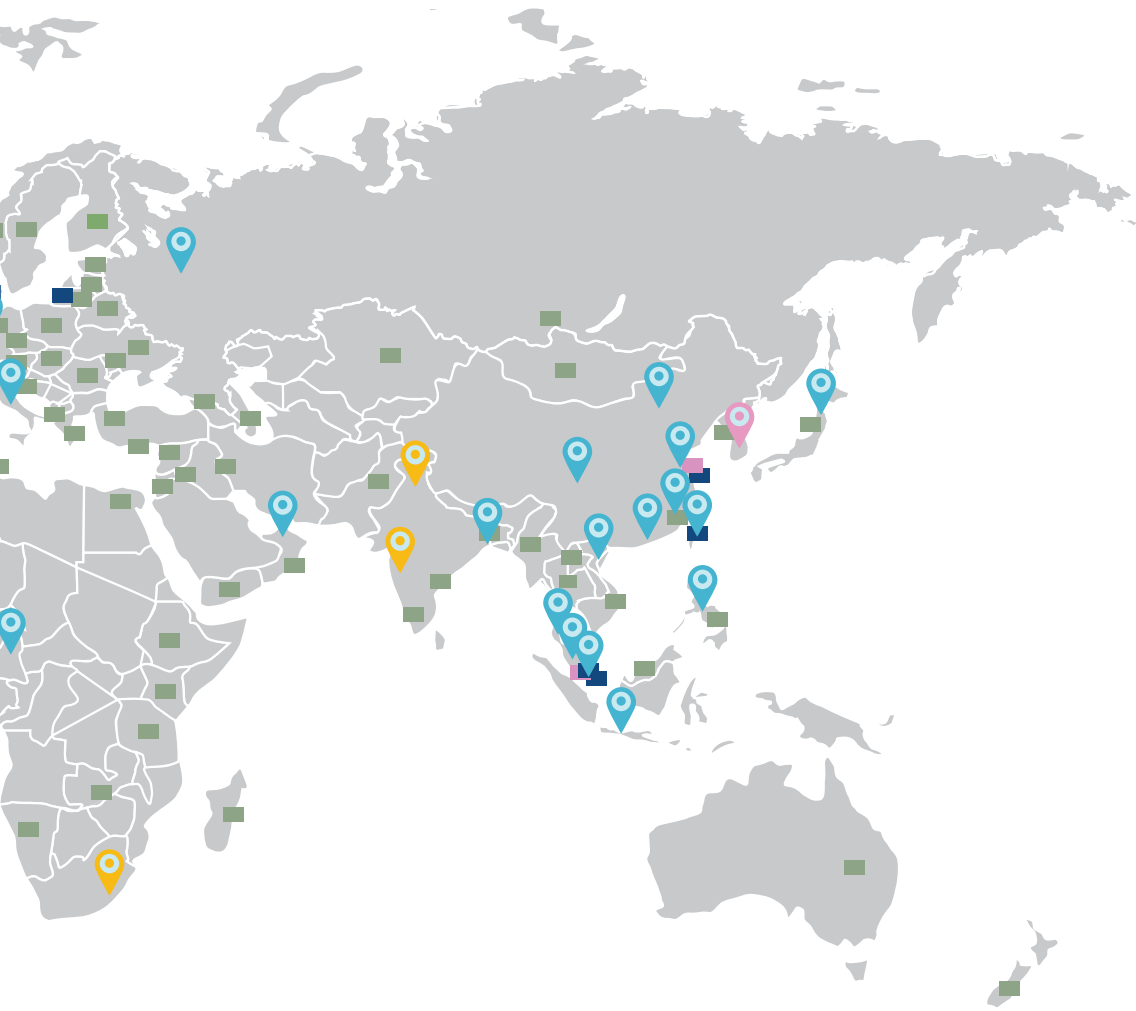

**Ascent™ Max Series
Model: ADC-C**

(with Secondary Carbon Filter)

- Main Filter : Carbon Filter
Secondary: Carbon Filter
- Optional VOC sensor
- Available sizes: 3,4,5,6 ft.



**Ascent™ Max Series
Model: ADC-D**

- Main Filter : Carbon Filter
- Transparent back wall made of tempered glass
- Optional VOC sensor
- Available sizes: 3,4,5,6 ft.



**Ascent™ Max Series
Model: ADC-E**

(with Secondary HEPA Filter)

- Main Filter : Carbon Filter
Secondary Filter: HEPA filter
- Optional VOC sensor
- Available sizes: 3,4,5 ft.

Esco Ductless

This type of fume hood is suitable for applications involving transfer of chemicals with no forced or with minimal evaporation. This is usually preferred for

1 type of filter (Main Carbon Filter)

2 ty

Sentinel™ Silver
Microprocessor Controller

Main
Seconda

AD

Optional VOC Sensor

Back Wall Optio

Back Wall Option

Acrylic Back Wall

Tempered Glass
Back Wall

EG Steel Back Wall

SPD-B Model

ADC-D Model

ADC-B Model

Fume Hood

chemicals, titration, sample preparation, weighing, extraction and experiments because of the hassle-free installation and of its plug and play feature.

Types of filter (Main Carbon Filter and Secondary Filter)

Sentinel™ Silver
Microprocessor Controller

Carbon Filter
+
Secondary Carbon Filter

DC-C Model

Main Carbon Filter
+
Secondary HEPA Filter

ADC-E Model

Not sure on the quantity of filter?

Fill out our FiltraCheck™ Form
and let us do the work!

<http://www.escoglobal.com/request-filtracheck.php>

FiltraCheck™ is now available in iOS and Android!

Get the real-time recommendation of
the appropriate fume hood models
and filters.

7

on

EG Steel Back Wall

SPD-A Model

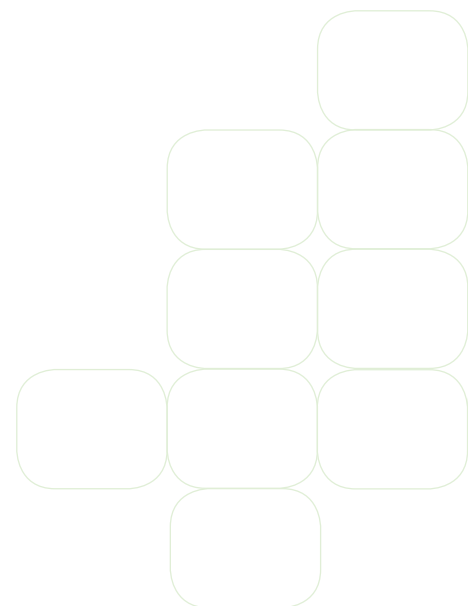

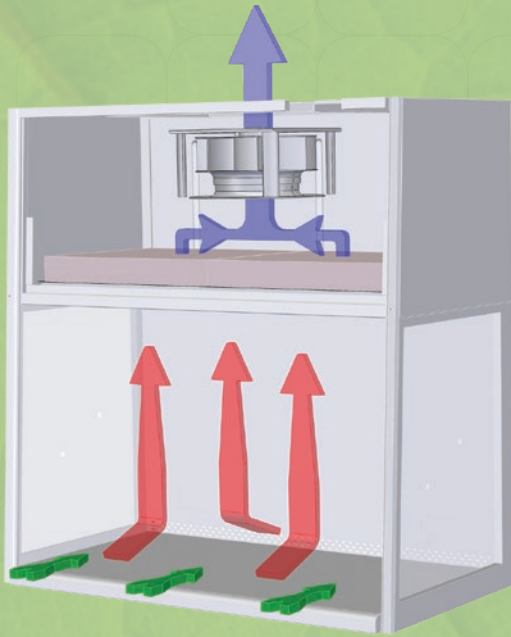

- Carbon-filtered air
- Unfiltered / potentially contaminated air
- Room air / Inflow air

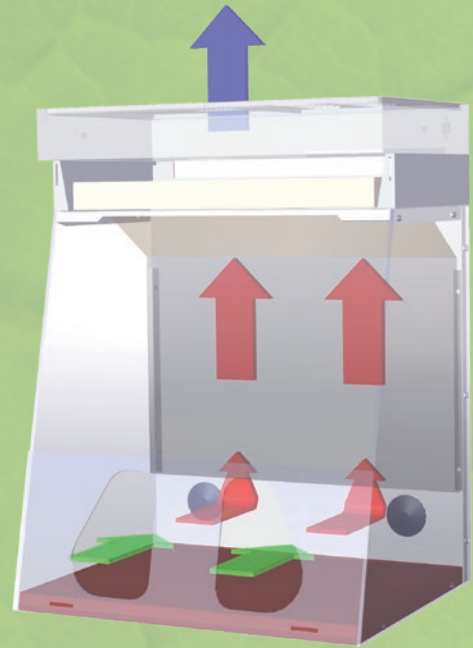

- Carbon-filtered air
- Unfiltered / potentially contaminated air
- Room air / Inflow air

Cabinet Filtration System

- The inflow moves from the ambient environment into the work zone through the hood front opening with an average velocity of 0.4 m/s.
- Negative pressure is maintained within the main chamber of the hood to ensure that no chemical fumes or vapors escape the work zone.
- Air is taken through a pre-filter and activated carbon mounted in the interior of the hood. The carbon filter removes all fumes from the exhaust air stream and filtered clean air is exhausted directly back to the room.

Esco Sentinel™ Silver Microprocessor Control System

Menu button - access the menu screen to change settings, admin pin, perform calibration and choose set mode

Set/Mute button - choose the menu or sub-menu displayed on the LCD screen - enables/disables Sash Alarm sound

Up and Down arrow buttons - selects the menu options -increase and decrease value inside menu options -moves the sash window upward and downward (for motorized sash only)

LCD Display -graphical interface indicates hood performance. Displays digital read-out with alpha-numeric display indicates all input, status and alarm function



Fan button -turns the fan on and off

Lamp button -turns the lamp on and off

Socket button -turns the electrical socket on and off - The maximum rating of all the outlets in the cabinet is 5 A.

(UV button is not applicable with ductless fume hoods)

Why Esco Ductless Fume Hoods?



The "GREEN" solution

- Environmentally friendly
- Does not discharge toxic gases to the environment
- Saves energy, and reduces total carbon footprint



Safe carbon filtration

- Compliance to international standards
- Proprietary Nanocarb™ activated carbon technology
- Industry-unique dual diffuser system on our Ascent™ Max fume hoods optimizes carbon filter life
- Optional VOC sensor system on our Ascent™ Max hoods detects filter saturation
- FiltraCheck™ service to qualify your application's suitability for a ductless solution
- Chemical Guide provides list of chemicals with specific suitability and safety data



Low cost

- No ductwork required
- No exhaust system required
- Saves the need for elaborate make-up air systems, in turn saving running costs required to condition make-up air



Convenience

- No installation hassle
- Mobile, flexible and easily relocatable



Guide to Ascent™ Opti Models

S P D - 4 B 1

1st Placeholder Model	Code	2nd Placeholder External Width	Code	3rd Placeholder Back Wall	Code	4th Placeholder Electrical	Code
Ascent™ Opti	D	0.9 m (3 ft)	3	EG Steel	A	220-240 VAC, 50 Hz	1
		1.2 m (4 ft)	4	Acrylic (transparent)	B	110-220 VAC, 60 Hz	2
						220-240 VAC, 60 Hz	3

Guide to Ascent™ Max Models

A D C - 4 B 1

1st Placeholder External Width	Code	2nd Placeholder Model	Code	3rd Placeholder Electrical	Code
0.6 m (2 ft)*	2	ADC-B (Standard Model)	B	220-240 VAC, 50 Hz	1
0.9 m (3 ft)	3	ADC-C (has Secondary Carbon Filter)	C	110-220 VAC, 60 Hz	2
1.2 m (4 ft)	4	ADC-D (Standard Model + Transparent Backwall)	D	220-240 VAC, 60 Hz	3
1.5 m (5 ft)	5	ADC-E (has Secondary HEPA Filter)	E		
1.8 m (6 ft)	6				

* 2 ft only available for ADC-B Models

ADC-B-M with motorized sash

ADC-B/C/D/E-PP -with swan neck faucet and PP sink provision

Esco Ascent™ Opti Ductless Fume Hood

Provides Operator and Environment Protection

Sample Port

Centrifugal Fan

- Permanently lubricated fans are energy efficient with external rotor motor design that reduces operating costs.
- Extremely low noise and low vibration level

Arm Ports

- Allows easy access to work zone without risking exposure from chemical fumes

Work Top

- Spill-retaining work top designed with a recessed central area contains accidental liquid spills

Industry Exclusive Baffle Design

- Integrating our experience with conventional fume hoods, Esco engineers designed a unique baffle for Ascent™ Opti Ductless Fume Hoods to improve containment and ensure the efficient removal of chemical fumes from the work zone

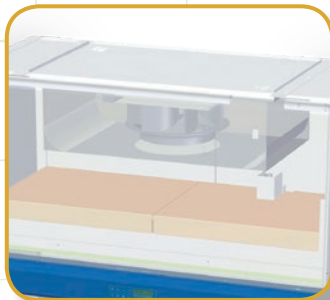

Ascent™ Opti Ductless Fume Hood, Model SPD-4A_ Shown with optional MBC-4A0 (mobile cart)

10

	Chemical Fume Containment	Filter Efficiency	Electrical Safety
Standards Compliance	ANSI / ASHRAE 110-1995, USA BS 7258, UK EN14175.3, Europe	BS 7989 - 2001, UK AFNOR NF X 15-211, France	UL-C-61010A-1, USA CAN/CSA-22.2, No.61010-1 EN-61010-1, Europe IEC61010-1, Worldwide

Ascent™

Ductless Fume Hood • Ascent™ Max Ductless Fume Hoods and Ascent™ Opti Ductless Fume Hoods



Sentinel™ Silver Microprocessor Control, Alarm System

- Advanced microprocessor control supervises operation of all hood functions. Temperature-compensated air velocity sensor monitors airflow
- 24-hour clock and blower run hour meter are standard



Nanocarb™ Activated Carbon Filters

- Optimized retention capacity
- Diffusion Technology to ensure even filter loading
- Efficient perimeter clamping ensures no leakage as well as allows for easy filter change procedure



Sash Window

- Double hinged sash mechanism allows higher sash opening for effortless cabinet loading



Mobile Cart

- Provides easy relocation
- Has fold-able trays for storage



Esco Ascent Ductless fume hood is certified to ASHRAE 110-1995 for fume containment at 0.5 m/s

Ascent™ Opti Line-up

Ascent™ Opti (SPD-_A)	Standard ductless fume hood
Ascent™ Opti (SPD-_B)	Ductless fume hood with transparent back wall ideal for classrooms and educational demonstrations
Powdermax®	Ductless fume hood with HEPA filter for powder weighing applications
ForMax	Ductless fume hood specialized as a formalin dispensing unit
RotaMax	Ductless fume hood designed to accommodate rotary evaporators
TitraMax	Ductless fume hood constructed for titration applications

Model SPD, Ascent™ Opti Ductless Fume Hood Engineering Drawing (0.9 to 1.2 m / 3 ft to 4 ft width models)

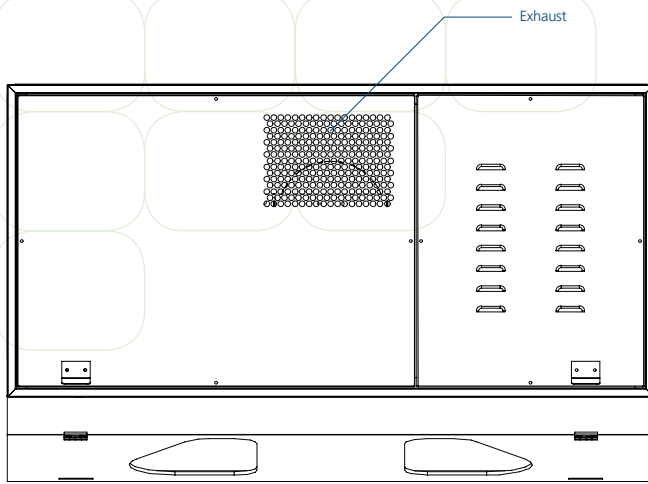

	A	B
SPD-3_	840 mm (33.1")	820 mm (32.3")
SPD-4_	1140 mm (44.9")	1116 mm (43.9")

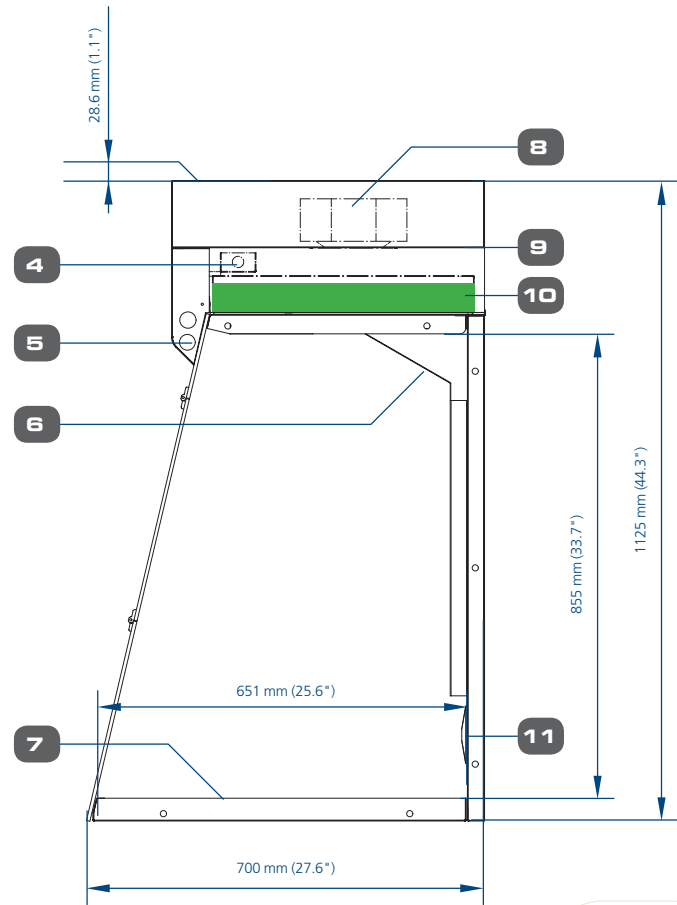
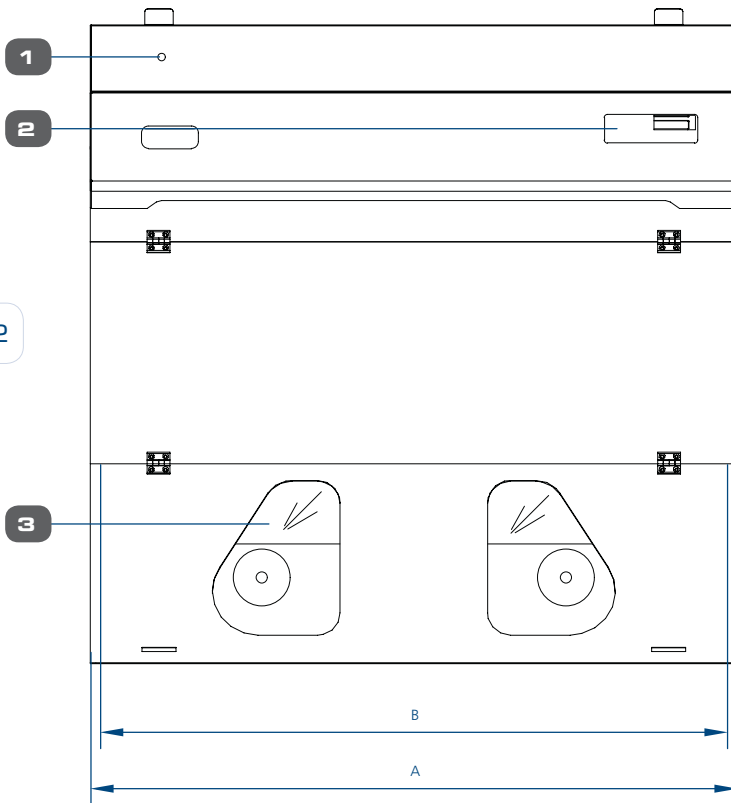

- 1. Sample Port
- 2. Esco Sentinel™ Silver Microprocessor Control System
- 3. Transparent Back Wall (SPD- B_ models only)
- 4. Airflow Sensor
- 5. Fluorescent Lamp
- 6. Baffle

- 7. Stainless Steel Worktop
- 8. Fan
- 9. Electrical Panel
- 10. Activated Carbon Filter
- 11. Pass-through ports for electrical or service connections

General Specifications, Ascent™ Opti Ductless Fume Hood

Model	220-240 VAC, 50 Hz	SPD-3A1 - 2040099	SPD-3B1 - 2040102	SPD-4A1 - 2040105	SPD-4B1 - 2040108
	110-120 VAC, 60 Hz	SPD-3A2 - 2040100	SPD-3B2 - 2040103	SPD-4A2 - 2040106	SPD-4B2 - 2040109
	220-240 VAC, 60 Hz	SPD-3A3 - 2040101	SPD-3B3 - 2040104	SPD-4A3 - 2040107	SPD-4B3 - 2040110
Nominal Size	0.9 meter (3')			1.2 meter (4')	
External Dimensions (W x D x H)	840 x 700 x 1125 mm (33.1" x 27.6" x 44.3")			1140 x 700 x 1125 mm (44.9" x 27.6" x 44.3")	
Internal Work Area (W x D x H)	820 x 651 x 855 mm (32.3" x 25.6" x 33.7")			1116 x 651 x 855 mm (43.9" x 25.6" x 33.7")	
Standard Filtration Elements	Pre-filter	Disposable, non washable polyester fiber, 85% arrestance, EU3 rated			
	Main filter*	Activated Carbon with Granular Media bed (8 different filter types available , codes A-H)			
Total Weight of Carbon Filter	15.4 Kg (34.0 lbs)		2 x 9.1 Kg each (2 x 20.1 lbs each)		
Control System	Esco Sentinel™ Silver Microprocessor Controller				
Airflow alarm	✓				
Inflow Air Velocity	Initial set point: 0.5 m/s (100 fpm)				
Sound Emission	<58 dBA at initial blower speed setting measured at typical operator work position				
Fluorescent Light Intensity	>350 lux (>28 foot-candles) at work surface level				
Hood Construction	Main Body	1.2 mm (0.05") 18 gauge electro-galvanized steel with white oven-baked epoxy-polyester Isocide™ antimicrobial powder coated finish			
	Front Window	6 mm acrylic			
	Back Walls	1.2 mm (0.05") 18 gauge electrogalvanized steel with white oven-baked epoxy-polyester Isocide™ antimicrobial powder coated finish	6 mm (0.2") Acrylic	1.2 mm (0.05") 18 gauge electrogalvanized steel with white oven-baked epoxy-polyester Isocide™ antimicrobial powder coated finish	6 mm (0.2") Acrylic
	Side Walls	9.5 mm (0.37") Acrylic			
	Work Top	1.5 mm (0.06") 16 gauge stainless steel type 304, with 4B finish			
Sash	Sloped Front	13°			
	Sash type	Hinged			
Electrical	220-240 VAC, 50 Hz, 1Φ	SPD-3A1 / SPD-3B1		SPD-4A1 / SPD-4B1	
	Cabinet Full Load Amps (FLA)	0.5 A		0.6 A	
	Cabinet Nominal Power	60 W		88 W	
	Cabinet BTU/Hr	205		300	
	110-120 VAC, 60 Hz, 1Φ	SPD-3A2 / SPD-3B2		SPD-4A2 / SPD-4B2	
	Cabinet Full Load Amps (FLA)	0.5 A		0.6 A	
	Cabinet Nominal Power	80 W		93 W	
	Cabinet BTU/Hr	273		317	
	220-240 VAC, 60 Hz, 1Φ	SPD-3A3 / SPD-3B3		SPD-4A3 / SPD-4B3	
	Cabinet Full Load Amps (FLA)	0.5 A		0.6 A	
Cabinet Nominal Power	80 W		93 W		
Cabinet BTU/Hr	273		317		
Net Weight**	86 kg (181 lbs)			105 Kg (231 lbs)	
Shipping Weight**	134 Kg (295 lbs)			160 Kg (353 lbs)	
Shipping Dimensions, Maximum (W x D x H)**	1050 X 1100 x 570 mm (41.3" x 43.3" x 22.4")			1300 x 1100 x 590 mm (51.2" x 43.3" x 23.2")	
Shipping Volume, Maximum**	1.5 m³ (53.0 cu.ft.)			1.9 m³ (67.1 cu.ft.)	

*Hood model order codes do not include filters. Order filters separately. When specified at time of order, filters will be factory installed.

**Hood only, excludes optional stand.

Esco Ascent™ Max Ductless Fume Hood

Provides Operator and Environment Protection

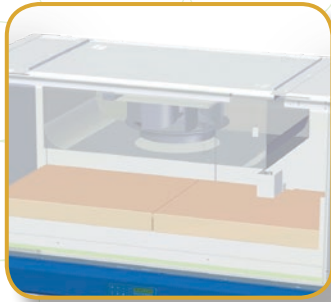

Centrifugal Fan

- Permanently lubricated fans are energy efficient with external rotor motor design that reduces operating costs.
- Extremely low noise and low vibration level

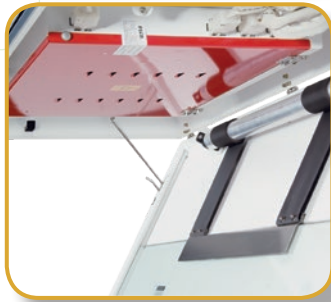

Robust Hood Construction

- Key components including Fluorescent Lamps, Motor Capacitor, Electrical Harness, Electronic Ballast, and Switch Control are mounted outside the airstream and away from contaminated areas to permit easy service.



Nanocarb™ Activated Carbon Filters

- Optimized retention capacity
- Diffusion technology to ensure even filter loading
- Efficient perimeter clamping ensures no leakage as well as allows easy filter change procedure.



Rear Walls

- Electro galvanized steel wall for superior durability



Work Top

- 1.5 mm, 16 gauge, type 304 stainless steel 4B finish
- Easy to clean, corrosion and chemical resistant makes it an ideal worktop for experiments



Ascent™ Max Ductless Fume Hood, Model ADC-4B. Shown with SAL-4A0 Gen2 (support stand with leveling feet).

14

Standards Compliance	Chemical Fume Containment	Filter Efficiency	Electrical Safety
	ANSI / ASHRAE 110-1995, USA BS 7258, UK AFNOR NF X 15-203, France EN14175.3, Europe	BS 7989 - 2001, UK AFNOR NF X 15-211, France	UL-C-61010-1, USA CAN/CSA-22.2, No.61010-1 EN-61010-1, Europe IEC61010-1, Worldwide

Ascent™

Ductless Fume Hood • Ascent™ Max Ductless Fume Hoods and Ascent™ Opti Ductless Fume Hoods

Sentinel™ Silver Microprocessor Control, Alarm System

- Advanced microprocessor control supervises operation of all hood functions. Temperature-compensated air velocity sensor monitors airflow. 24-hour clock and blower run hour meter are standard.



Optional VOC Sensor



- Detects presence of volatile organic compounds in the exhaust and alarms to indicate filter saturation



ISOCIDE™ Powder Coat

- Silver-ion impregnated powder coat
- Inhibit microbial growth to improve safety

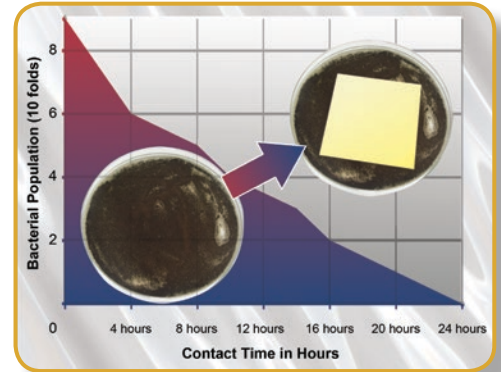

15

Sash Window

- 3° sloped front allows easy access to work zone - enhancing ergonomics, eliminating operator fatigue and increasing productivity



Auto Purge Slots

- Improves containment and operator protection by preventing accumulation of fumes in the work zone



Support Stand

- Made from durable material to support a maximum weight of 500-600 Kg (1102 - 1322 lbs)
- Available in two standard heights (28" and 34")



Esco Ascent Ductless fume hood is certified to ASHRAE 110-1995 for fume containment at 0.4 m/s

Model ADC-_B_ & ADC-_D_ (with Tempered Glass Back Wall), Ascent™ Max Ductless Fume Hood Engineering Drawing

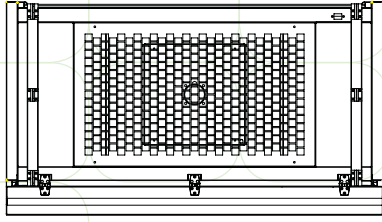

1. Esco Sentinel™ Silver Microprocessor Control System
2. Tempered Glass Sliding Sash Window
3. Tempered Glass Back Wall
(for ADC-_D_ 3,4,5 and 6 units) /
EG Steel (for ADC-_B_ 2,3,4,5 and 6 units)
4. Electrical Outlet Retrofit Kit Provision
5. AutoPurge™ Slots
6. VOC sensor (optional)

7. Electrical Panel
8. Fluorescent Lamp
9. Fan
10. Main Carbon filter
11. Prefilter (built inside the carbon filter)
12. Tempered Glass Sides
13. Service Fixture Retrofit Kit Provision
(2 on each side)
14. Stainless Steel Worktop

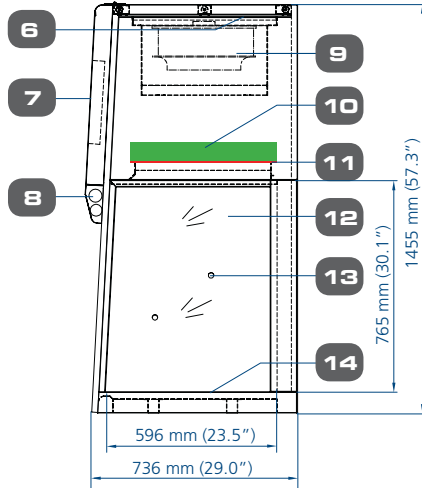
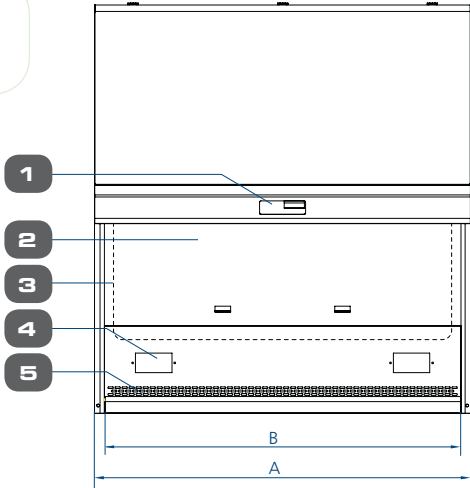

	A	B
ADC-2B_	730 mm (28.7")	660 mm (25.9")
ADC-3B_ / ADC-3D_	1035 mm (40.7")	965 mm (38.0")
ADC-4B_ / ADC-4D_	1340 mm (52.8")	1270 mm (50.0")
ADC-5B_ / ADC-5D_	1645 mm (64.8")	1575 mm (62.0")
ADC-6B_ / ADC-6D_	1950 mm (76.8")	1880 mm (74.0")

16

	220-240 VAC, 50 Hz, 1Φ		ADC-2B1	ADC-3B1	ADC-4B1	ADC-5B1	ADC-6B1
		ADC-2B1-M	ADC-3B1-M	ADC-4B1-M	ADC-5B1-M	ADC-6B1-M	
	ADC-2B1-PP	ADC-3B1-PP	ADC-4B1-PP	ADC-5B1-PP	ADC-6B1-PP		
		ADC-3D1	ADC-4D1	ADC-5D1	ADC-6D1		
		ADC-3D1-PP	ADC-4D1-PP	ADC-5D1-PP	ADC-6D1-PP		
Cabinet Full Load Amps (FLA)		1 A	2 A	2 A	3 A	3 A	
Optional Outlets (FLA)				5 A			
Cabinet Nominal Power		128 W	236 W	264 W	300 W	339 W	
Cabinet BTU/Hr		437	805	901	1024	1157	
	110-120 VAC, 60 Hz, 1Φ		ADC-2B2	ADC-3B2	ADC-4B2	ADC-5B2	ADC-6B2
		ADC-2B2-M	ADC-3B2-M	ADC-4B2-M	ADC-5B2-M	ADC-6B2-M	
	ADC-2B2-PP	ADC-3B2-PP	ADC-4B2-PP	ADC-5B2-PP	ADC-6B2-PP		
		ADC-3D2	ADC-4D2	ADC-5D2	ADC-6D2		
		ADC-3D2-PP	ADC-4D2-PP	ADC-5D2-PP	ADC-6D2-PP		
Cabinet Full Load Amps (FLA)		3.5 A	3.5 A	3.5 A	4 A	4 A	
Optional Outlets (FLA)				5 A			
Cabinet Nominal Power		136 W	238 W	275 W	315 W	345 W	
Cabinet BTU/Hr		464	812	938	1075	1177	
	220-240 VAC, 60 Hz, 1Φ		ADC-2B3	ADC-3B3	ADC-4B3	ADC-5B3	ADC-6B3
		ADC-2B3-M	ADC-3B3-M	ADC-4B3-M	ADC-5B3-M	ADC-6B3-M	
	ADC-2B3-PP	ADC-3B3-PP	ADC-4B3-PP	ADC-5B3-PP	ADC-6B3-PP		
		ADC-3D3	ADC-4D3	ADC-5D3	ADC-6D3		
		ADC-3D3-PP	ADC-4D3-PP	ADC-5D3-PP	ADC-6D3-PP		
Cabinet Full Load Amps (FLA)		1 A	2 A	2 A	3 A	3 A	
Optional Outlets (FLA)				5 A			
Cabinet Nominal Power		172 W	257 W	357 W	360 W	460 W	
Cabinet BTU/Hr		587	877	1218	1228	1570	

General Specifications, Ascent™ Max (B and D series) Ductless Fume Hood

Model	220-240 VAC, 50 Hz	ADC-2B1 - 2040018	ADC-3B1 - 2040024	ADC-4B1 - 2040042	ADC-5B1 - 2040060	ADC-6B1 - 2040078
				ADC-3B1-M - 2040026	ADC-4B1-M - 2040045	ADC-5B1-M - 2040062
		ADC-2B1-PP - 2040198	ADC-3B1-PP - 2040161	ADC-4B1-PP - 2040128	ADC-5B1-PP - 2040134	ADC-6B1-PP - 2040140
			ADC-3D1 - 2040036	ADC-4D1 - 2040054	ADC-5D1 - 2040072	ADC-6D1 - 2040090
			ADC-3D1-PP - 2040167	ADC-4D1-PP - 2040146	ADC-5D1-PP - 2040149	ADC-6D1-PP - 2040152
	110-120 VAC, 60 Hz	ADC-2B2 - 2040020	ADC-3B2 - 2040027	ADC-4B2 - 2040046	ADC-5B2 - 2040063	ADC-6B2 - 2040079
			ADC-3B2-M - 2040029	ADC-4B2-M - 2040048	ADC-5B2-M - 2040065	ADC-6B2-M - 2040084
		ADC-2B2-PP - 2040183	ADC-3B2-PP - 2040162	ADC-4B2-PP - 2040129	ADC-5B2-PP - 2040135	ADC-6B2-PP - 2040141
			ADC-3D2 - 2040037	ADC-4D2 - 2040055	ADC-5D2 - 2040073	ADC-6D2 - 2040091
			ADC-3D2-PP - 2040168	ADC-4D2-PP - 2040147	ADC-5D2-PP - 2040150	ADC-6D2-PP - 2040153
	220-240 VAC, 60 Hz	ADC-2B3 - 2040022	ADC-3B3 - 2040030	ADC-4B3 - 2040049	ADC-5B3 - 2040066	ADC-6B3 - 2040080
			ADC-3B3-M - 2040032	ADC-4B3-M - 2040050	ADC-5B3-M - 2040068	ADC-6B3-M - 2040086
		ADC-2B3-PP - 2040212	ADC-3B3-PP - 2040163	ADC-4B3-PP - 2040130	ADC-5B3-PP - 2040136	ADC-6B3-PP - 2040142
			ADC-3D3 - 2040038	ADC-4D3 - 2040056	ADC-5D3 - 2040074	ADC-6D3 - 2040092
			ADC-3D3-PP - 2040169	ADC-4D3-PP - 2040148	ADC-5D3-PP - 2040151	ADC-6D3-PP - 2040154
Nominal Size		0.6 meter (2')	0.9 meter (3')	1.2 meter (4')	1.5 meter (5')	1.8 meter (6')
External Dimensions (W x D x H)		730 x 736 x 1460 mm (28.7" x 29.0" x 57.5")	1035 x 736 x 1455 mm (40.7" x 29.0" x 57.3")	1340 x 736 x 1455 mm (52.8" x 29.0" x 57.3")	1645 x 736 x 1455 mm (64.8" x 29.0" x 57.3")	1950 x 736 x 1455 mm (76.8" x 29.0" x 57.3")
Internal Work Area (W x D x H)		660 x 596 x 765 mm (26.0" x 23.5" x 30.1")	965 x 596 x 765 mm (38.0" x 23.5" x 30.1")	1268 x 596 x 765 mm (50.0" x 23.5" x 30.1")	1575 x 596 x 765 mm (62.0" x 23.5" x 30.1")	1880 x 596 x 765 mm (74.0" x 23.5" x 30.1")
Standard Filtration Elements	Pre-filter	Disposable, non-washable polyester fibre, 85% arrestance, EU3 rated				
	Main filter*	Activated carbon with granular media bed (8 different filter types available, codes A to H)				
Total Weight of Carbon Filter		8.5 Kg (18.7 lbs.)	2 x 10.3 Kg each (2 x 22.7 lbs each)	2 x 13.9 Kg each (2 x 30.6 lbs each)	2 x 17.4 Kg each (2 x 38.4 lbs each)	3 x 13.9 Kg each (3 x 30.6 lbs each)
Control System	Esco Sentinel™ Silver Microprocessor Controller					
VOC Sensor	Optional					
Airflow alarm	✓					
AutoPurge Slots	✓					
Inflow Air Velocity	Initial set point: 0.40 m/s (80 fpm)					
Sound Emission		55 dBA		57 dBA		58 dBA
Fluorescent Light Intensity	>1000 lux (>93 foot-candles)					
Hood Construction	Main Body	1.2 mm (0.05") 18 gauge electro-galvanized steel with white oven-baked epoxy-polyester Isocide™ antimicrobial powder coated finish				
	Back Walls	1.2 mm (0.05") 18 gauge electrogalvanized steel with white oven-baked epoxy-polyester Isocide™ antimicrobial powder coated finish - (B-Series)				
		Tempered glass - (D-Series)				
	Side Walls	Tempered Glass				
Work Top	1.5 mm (0.06") 16 gauge stainless steel, type 304, with 4B finish					
Sash	Sloped Front	3°				
	Sash Type	Vertical Sliding for models ADC-_B/D_ and ADC-_B/D_-PP / Motorized Sash for models ADC-_B_-M				
Net Weight**		130 kg (286 lbs)	175 kg (386 lbs)	225 kg (496 lbs)	245 kg (540 lbs)	293 kg (646 lbs)
Shipping Weight**		164 kg (362 lbs)	205 kg (452 lbs)	261 kg (575 lbs)	320 kg (705 lbs)	380 kg (838 lbs)
Shipping Dimensions, Maximum (W x D x H)**		800 x 820 x 1750 mm (31.5" x 32.3" x 68.9")	1130 x 840 x 1750 mm (44.5" x 33.0" x 68.9")	1410 x 840 x 1750 mm (55.5" x 33.0" x 68.9")	1730 x 840 x 1750 mm (68.1" x 33.0" x 68.9")	2050 x 840 x 1750 mm (80.7" x 33.0" x 68.9")
Shipping Volume, Maximum**		1.14 m ³ (40.3 cu.ft)	1.66 m ³ (58.6 cu.ft)	2.07 m ³ (73.1 cu.ft)	2.51 m ³ (88.6 cu.ft)	3.01 m ³ (106.3 cu.ft)

*Hood model order codes do not include filters. Order filters separately. When specified at time of order, filters will be factory installed.

**Hood only, excludes optional stand.

Model ADC_C_, Ascent™ Max Ductless Fume Hood Engineering Drawing (with Secondary Backup Carbon Filter)

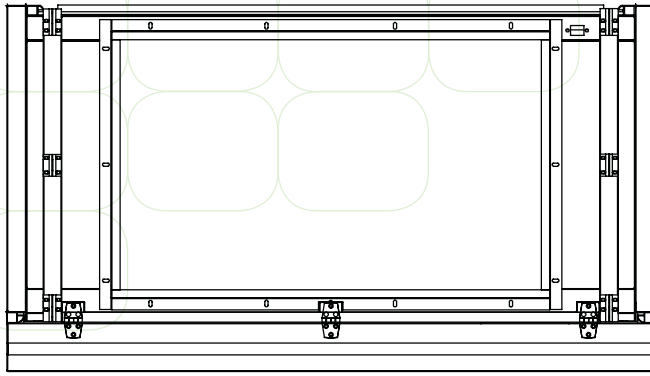

	A	B
ADC-3C_	1035 mm (40.7")	965 mm (38.0")
ADC-4C_	1340 mm (52.8")	1270 mm (50.0")
ADC-5C_	1645 mm (64.8")	1575 mm (62.0")
ADC-6C_	1950 mm (76.8")	1880 mm (74.0")

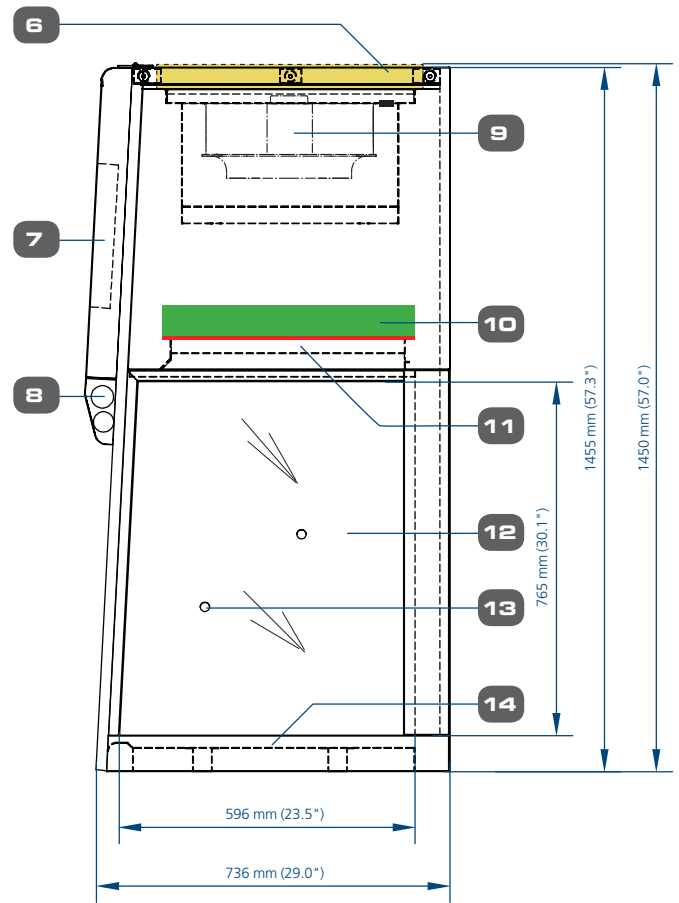
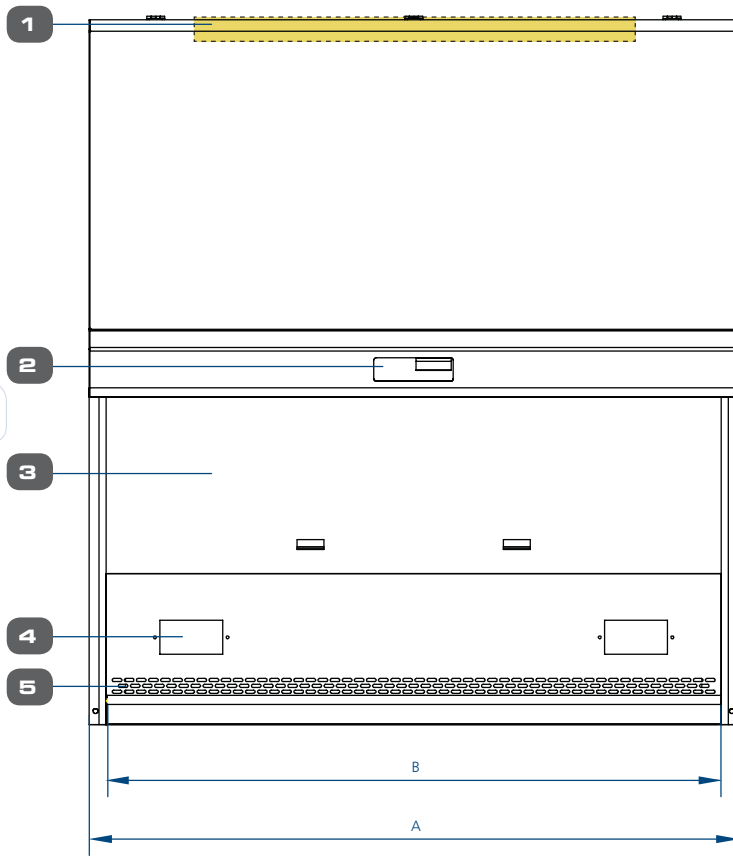

- 1. Back up Carbon Filter
- 2. Esco Sentinel™ Silver Microprocessor Control System
- 3. Tempered Glass Sliding Sash Window
- 4. Electrical Outlet
- 5. AutoPurge™ Slots
- 6. VOC sensor (optional)
- 7. Electrical Panel

- 8. Fluorescent Lamps
- 9. Fan
- 10. Main Carbon Filter
- 11. Pre-filter (built inside the carbon filter)
- 12. Tempered Glass Sides
- 13. Service Fixture Retrofit Kit Provision (2 on each side)
- 14. Stainless Steel Worktop

General Specifications, Ascent™ Max (C series) Ductless Fume Hood

Model	220-240 VAC, 50 Hz	ADC-3C1 - 2040033	ADC-4C1 - 2040051	ADC-5C1 - 2040069	ADC-6C1 - 2040087
		ADC-3C1-PP - 2040164	ADC-4C1-PP - 2040131	ADC-5C1-PP - 2040137	ADC-6C1-PP - 2040143
	110-120 VAC, 60 Hz	ADC-3C2 - 2040034	ADC-4C2 - 2040052	ADC-5C2 - 2040070	ADC-6C2 - 2040088
		ADC-3C2-PP - 2040165	ADC-4C2-PP - 2040132	ADC-5C2-PP - 2040138	ADC-6C2-PP - 2040144
	220-240 VAC, 60 Hz	ADC-3C3 - 2040035	ADC-4C3 - 2040053	ADC-5C3 - 2040071	ADC-6C3 - 2040089
		ADC-3C3-PP - 2040166	ADC-4C3-PP - 2040133	ADC-5C3-PP - 2040139	ADC-6C3-PP - 2040145
Nominal Size		0.9 meter (3')	1.2 meter (4')	1.5 meter (4')	1.8 meter (6')
External Dimensions (W x D x H)		1035 x 736 x 1455 mm (40.7" x 29.0" x 57.3")	1340 x 736 x 1455 mm (52.8" x 29.0" x 57.3")	1645 x 736 x 1455 mm (64.8" x 29.0" x 57.3")	1950 x 736 x 1455 mm (76.8" x 29.0" x 57.3")
Internal Work Area (W x D x H)		965 x 596 x 765 mm (38.0" x 23.5" x 30.1")	1268 x 596 x 765 mm (50.0" x 23.5" x 30.1")	1575 x 596 x 765 mm (62.0" x 23.5" x 30.1")	1880 x 596 x 765 mm (74.0" x 23.5" x 30.1")
Standard Filtration Elements	Pre-filter	Disposable, non-washable polyester fibre, 85% arrestance, EU3 rated			
	Main filter*	Activated Carbon with Granular Media bed (8 different filter types available, codes A-H)			
	Back-up Filter	Activated Carbon with Granular Media bed (8 different filter types available, codes A-H)			
Total Weight of Carbon Filter		2 x 10.3 Kg each (2 x 22.7 lbs each)	2 x 13.9 Kg each (2 x 30.6 lbs each)	2 x 17.4 Kg each (2 x 38.3 lbs each)	3 x 13.9 Kg each (3 x 30.6 lbs each)
Control System	Esco Sentinel™ Silver Microprocessor Controller				
VOC Sensor	Optional				
Airflow alarm	✓				
Auto-Purge Slots	✓				
Inflow Air Velocity	Initial set point: 0.40 m/s (80 fpm)				
Sound Emission		60 dBA		61 dBA	62 dBA
Fluorescent Light Intensity		>1141 lux (>106 foot-candles)	>1397 lux (>130 foot-candles)	>1141 lux (>106 foot-candles)	>1060 lux (>99 Ft.-candles)
Hood Construction	Main Body	1.2 mm (0.05") 18 gauge electro-galvanized steel with white oven-baked epoxy-polyester Isocide™ antimicrobial powder coated finish			
	Side Walls	Tempered Glass			
	Work Top	1.5 mm (0.06") 16 gauge stainless steel, type 304, with 4B finish			
Sash	Sloped Front	3°			
	Sash Type	Vertical Sliding or Optional Motorized Sash			
Electrical	220-240 VAC, 50 Hz, 1Φ	ADC-3C1 / ADC-3C1-PP	ADC-4C1 / ADC-4C1-PP	ADC-5C1 / ADC-5C1-PP	ADC-6C1 / ADC-6C1-PP
	Cabinet Full Load Amps (FLA)	2 A	2 A	3 A	3 A
	Optional Outlets (FLA)	5 A			
	Cabinet Nominal Power	250 W	290 W	242 W	350 W
	Cabinet BTU/Hr	853	990	826	1194
	110-120 VAC, 60 Hz, 1Φ	ADC-3C2 / ADC-3C2-PP	ADC-4C2 / ADC-4C2-PP	ADC-5C2 / ADC-5C2-PP	ADC-6C2 / ADC-6C2-PP
	Cabinet Full Load Amps (FLA)	3.5 A	3.5 A	4 A	4 A
	Optional Outlets (FLA)	5 A			
	Cabinet Nominal Power	282 W	314 W	349 W	360 W
	Cabinet BTU/Hr	962	1071	1191	1228
	220-240 VAC, 60 Hz, 1Φ	ADC-3C3 / ADC-3C3-PP	ADC-4C3 / ADC-4C3-PP	ADC-5C3 / ADC-5C3-PP	ADC-6C3 / ADC-6C3-PP
	Cabinet Full Load Amps (FLA)	2 A	2 A	3 A	3 A
	Optional Outlets (FLA)	5 A			
	Cabinet Nominal Power	270 W	355 W	430 W	473 W
	Cabinet BTU/Hr	921	1211	1467	1614
Net Weight**		175 kg (386 lbs)	225 kg (496 lbs)	245 kg (540 lbs)	293 kg (646 lbs)
Shipping Weight**		253 kg (558 lbs)	336 kg (741 lbs)	336 kg (741 lbs)	398 kg (877 lbs)
Shipping Dimensions, Maximum (W x D x H)**		1130 x 840 x 1750 mm (44.5" x 33.1" x 68.9")	1450 x 840 x 1750 mm (57.1" x 33.1" x 68.9")	1750 x 840 x 1750 mm (68.9" x 33.1" x 68.9")	2020 x 840 x 1750 mm (79.5" x 33.1" x 68.9")
Shipping Volume, Maximum**		1.66 m³ (58.6 cu.ft)	2.13 m³ (75.2 cu.ft)	2.57 m³ (90.8 cu.ft)	2.96 m³ (104.5 cu.ft)

* Hood model order codes do not include filters. Order filters separately. When specified at time of order, filters will be factory installed.

** Hood only, excludes optional stand.

Model ADC-E_, Ascent™ Max Ductless Fume Hood Engineering Drawing (with Secondary Backup HEPA Filter)

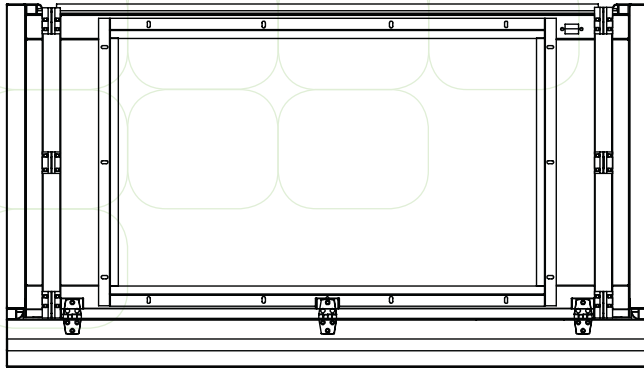

	A	B
ADC-3E_	1035 mm (40.7")	965 mm (38.0")
ADC-4E_	1340 mm (52.8")	1270 mm (50.0")
ADC-5E_	1645 mm (64.8")	1575 mm (62.0")

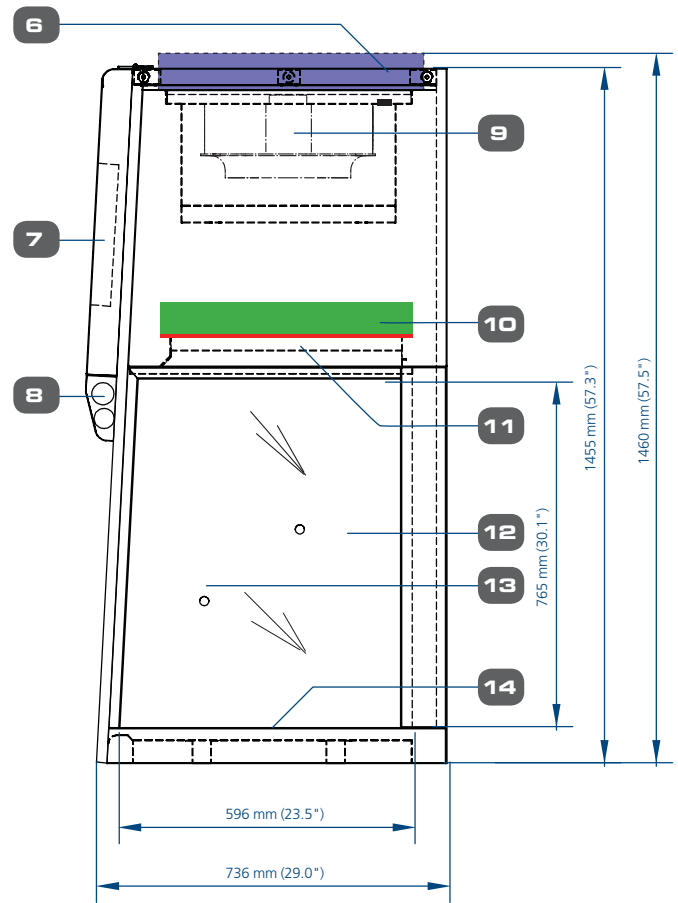
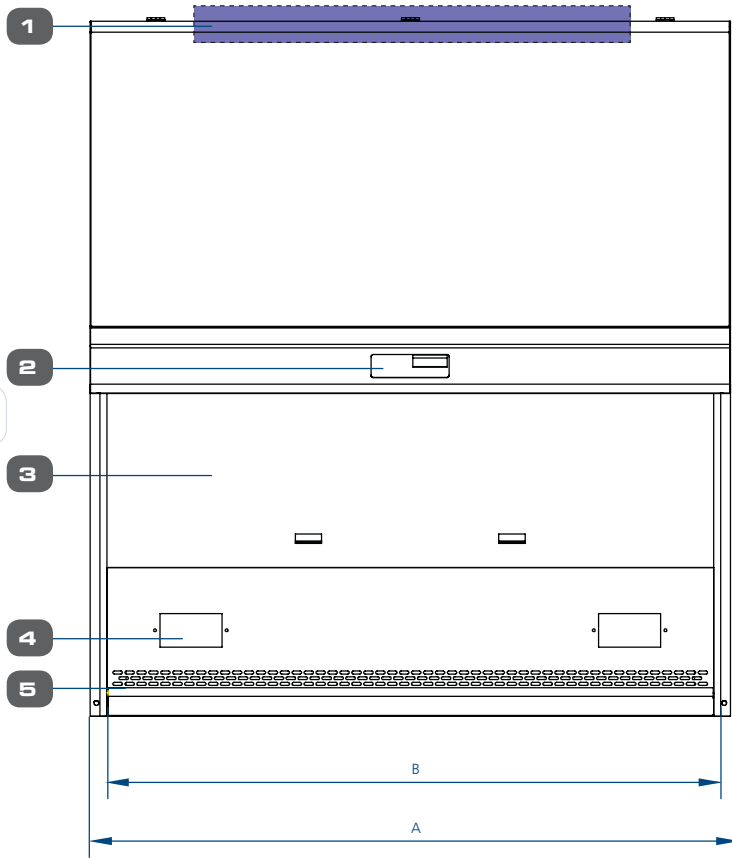

1. Back up HEPA Filter
2. Esco Sentinel™ Silver Microprocessor Control System
3. Tempered Glass Sliding Sash Window
4. Electrical Outlet
5. AutoPurge™ Slots
6. VOC Sensor (optional)
7. Electrical Panel

8. Fluorescent Lamp
9. Fan
10. Main Carbon Filter
11. Pre-filter (built inside the carbon filter)
12. Tempered Glass Side
13. Service Fixture Retrofit Kit Provision (2 on each side)
14. Stainless Steel Worktop

General Specifications, Ascent™ Max (E series) Ductless Fume Hood

Model		220-240 VAC, 50 Hz		220-240 VAC, 60 Hz			
		ADC-3E1 - 2040039	ADC-4E1 - 2040057	ADC-5E1 - 2040075	ADC-3E1-PP - 2040170	ADC-4E1-PP - 2040155	ADC-5E1-PP - 2040158
Model		110-120 VAC, 60 Hz		220-240 VAC, 60 Hz			
		ADC-3E2 - 2040040	ADC-4E2 - 2040058	ADC-5E2 - 2040076	ADC-3E2-PP - 2040171	ADC-4E2-PP - 2040156	ADC-5E2-PP - 2040159
Model		220-240 VAC, 60 Hz		220-240 VAC, 60 Hz			
		ADC-3E3 - 2040041	ADC-4E3 - 2040059	ADC-5E3 - 2040077	ADC-3E3-PP - 2040172	ADC-4E3-PP - 2040175	ADC-5E3-PP - 2040160
Nominal Size		0.9 meter (3')		1.2 meter (4')		1.5 meter (5')	
External Dimensions (W x D x H)		1035 x 736 x 1455 mm (40.7" x 29.0" x 57.3")		1340 x 736 x 1455 mm (52.8" x 29.0" x 57.3")		1645 x 736 x 1455 mm (64.8" x 29.0" x 57.3")	
Internal Work Area (W x D x H)		965 x 596 x 765 mm (38.0" x 23.5" x 30.1")		1268 x 596 x 765 mm (50.0" x 23.5" x 30.1")		1575 x 596 x 765 mm (62.0" x 23.5" x 30.1")	
Standard Filtration Elements	Pre-filter	Disposable, non-washable polyester fibre, 85% arrestance, EU3 rated					
	Main filter*	Activated Carbon with Granular Media bed (8 different filter types available, codes A-H)					
	Back-up Filter	HEPA filter, typical efficiency of >99.99% at 0.3 microns, removes particles and aerosols					
Total Weight of Carbon Filter		2 x 10.3 Kg each (2 x 22.7 lbs each)		2 x 13.9 Kg each (2 x 30.6 lbs each)		2 x 17.4 Kg each (2 x 38.3 lbs each)	
Control System		Esco Sentinel™ Silver Microprocessor Controller					
VOC Sensor		Optional					
Airflow alarm		✓					
Auto-Purge Slots		✓					
Inflow Air Velocity		Initial set point: 0.40 m/s or 80 fpm					
Sound Emission		61 dBA			62 dBA		
Fluorescent Light Intensity		>1115 lux (>104 foot-candles)		>1107 lux (>103 foot-candles)		>1082 lux (>101 foot-candles)	
Hood Construction	Main Body	1.2 mm (0.05") 18 gauge electro-galvanized steel with white oven-baked epoxy-polyester Isocide™ antimicrobial powder coated finish					
	Side Walls	Tempered Glass					
	Work Top	1.5 mm (0.06") 16 gauge stainless steel, type 304, with 4B finish					
Sash	Sloped Front	3°					
	Sash Type	Vertical Sliding or Optional Motorized Sash					
Electrical	220-240 VAC, 50 Hz, 1Φ	ADC-3E1 / ADC-3E1-PP		ADC-4E1 / ADC-4E1-PP		ADC-5E1 / ADC-5E1-PP	
	Cabinet Full Load Amps (FLA)	2 A		2 A		3 A	
	Optional Outlets (FLA)	5 A					
	Cabinet Nominal Power	250 W		290 W		242 W	
	Cabinet BTU/Hr	853		990		826	
	110-120 VAC, 60 Hz, 1Φ	ADC-3E2 / ADC-3E2-PP		ADC-4E2 / ADC-4E2-PP		ADC-5E2 / ADC-5E2-PP	
	Cabinet Full Load Amps (FLA)	3.5 A		3.5 A		4 A	
	Optional Outlets (FLA)	5 A					
	Cabinet Nominal Power	282 W		314 W		349 W	
	Cabinet BTU/Hr	962		1071		1191	
	220-240 VAC, 60 Hz, 1Φ	ADC-3E3 / ADC-3E3-PP		ADC-4E3 / ADC-4E3-PP		ADC-5E3 / ADC-5E3-PP	
	Cabinet Full Load Amps (FLA)	2 A		2 A		3 A	
	Optional Outlets (FLA)	5 A					
	Cabinet Nominal Power	270 W		355 W		430 W	
	Cabinet BTU/Hr	921		1211		1467	
	Net Weight**		175 kg (386 lbs)		225 kg (496 lbs)		245 kg (540 lbs)
Shipping Weight**		216 kg (476 lbs)		274 kg (604 lbs)		335 kg (739 lbs)	
Shipping Dimensions, Maximum (W x D x H)**		1130 x 840 x 1750 mm (44.5" x 33.1" x 68.9")		1450 x 840 x 1750 mm (57.1" x 33.1" x 68.9")		1750 x 840 x 1750 mm (68.9" x 33.1" x 68.9")	
Shipping Volume, Maximum**		1.66 m³ (58.6 cu.ft)		2.13 m³ (75.2 cu.ft)		2.57 m³ (90.8 cu.ft)	

*Hood model order codes do not include filters. Order filters separately. When specified at time of order, filters will be factory installed.

**Hood only, excludes optional stand.

Accessories and Options for Ductless Fume hood

Item Code	Model	Description
Support Stands for Ascent™ Max		
5130161	SPC-2A0 Gen2	Support Stand for 2 ft. fume hood with Caster Wheels, (Height 28")
5130155	SPC-3A0 Gen2	Support Stand for 3 ft. fume hood with Caster Wheels, (Height 28")
5130152	SPC-4A0 Gen2	Support Stand for 4 ft. fume hood with Caster Wheels, (Height 28")
5130162	SPC-5A0 Gen2	Support Stand for 5 ft. fume hood with Caster Wheels, (Height 28")
5130154	SPC-6A0 Gen2	Support Stand for 6 ft. fume hood with Caster Wheels, (Height 28")
5130164	SPC-2B0 Gen2	Support Stand for 2 ft. fume hood with Caster Wheels (Height 34")
5130165	SPC-3B0 Gen2	Support Stand for 3 ft. fume hood with Caster Wheels, (Height 34")
5130166	SPC-4B0 Gen2	Support Stand for 4 ft. fume hood with Caster Wheels, (Height 34")
5130167	SPC-5B0 Gen2	Support Stand for 5 ft. fume hood with Caster Wheels, (Height 34")
5130168	SPC-6B0 Gen2	Support Stand for 6 ft. fume hood with Caster Wheels, (Height 34")
5130169	SAL-2A0 Gen2	Support Stand for 2 ft. fume hood with Leveling Feet (Height 28")
5130170	SAL-3A0 Gen2	Support Stand for 3 ft. fume hood with Leveling Feet (Height 28")
5130134	SAL-4A0 Gen2	Support Stand for 4 ft. fume hood with Leveling Feet (Height 28")
5130171	SAL-5A0 Gen2	Support Stand for 5 ft. fume hood with Leveling Feet (Height 28")
5130172	SAL-6A0 Gen2	Support Stand for 6 ft. fume hood with Leveling Feet (Height 28")
5130173	SAL-2B0 Gen2	Support Stand for 2 ft. fume hood with Leveling Feet (Height 34")
5130174	SAL-3B0 Gen2	Support Stand for 3 ft. fume hood with Leveling Feet (Height 34")
5130175	SAL-4B0 Gen2	Support Stand for 4 ft. fume hood with Leveling Feet (Height 34")
5130176	SAL-5B0 Gen2	Support Stand for 5 ft. fume hood with Leveling Feet (Height 34")
5130177	SAL-6B0 Gen2	Support Stand for 6 ft. fume hood with Leveling Feet (Height 34")
2040011	BCC-4A0	Base Cabinet for 4 ft. fume hood (Height 28")
2040209	BCC-4B0	Base Cabinet for 4 ft. fume hood (Height 34")
Mobile Cart for Ascent™ Opti		
5130196	MBC-3A0	Mobile Cart for SPD-3A/B, PW1-3A
5130192	MBC-4A0	Mobile Cart for SPD-4A/B
Exhaust Collar		
5170154	ECO-SPD3A	Exhaust Collar for SPD-3A
5170155	ECO-SPD4A	Exhaust Collar for SPD-4A
5170141	ECO-ADC3B	Exhaust Collar for ADC-3B/D; 10" (254 mm) diameter exhaust collar
5170143	ECO-ADC4B	Exhaust Collar for ADC-4B/D/E; 10" (254 mm) diameter exhaust collar
5170145	ECO-ADC5B	Exhaust Collar for ADC-5B/D; 10" (254 mm) diameter exhaust collar
5170147	ECO-ADC6B	Exhaust Collar for ADC-6B/D; 10" (254 mm) diameter exhaust collar
5170442	ECO-ADC3C	Exhaust Collar for ADC-3C; 10" (254 mm) diameter exhaust collar
5170435	ECO-ADC4C	Exhaust Collar for ADC-4C; 10" (254 mm) diameter exhaust collar
5170539	ECO-ADC5C	Exhaust Collar for ADC-5C; 10" (254 mm) diameter exhaust collar
5170148	ECO-ADC6C	Exhaust Collar for ADC-6C; 10" (254 mm) diameter exhaust collar
5170559	ECO-ADC3E	Exhaust Collar for ADC-3E; 10" (254 mm) diameter exhaust collar
5170323	ECO-ADC5E	Exhaust Collar for ADC-5E; 10" (254 mm) diameter exhaust collar
Utility Fittings (Maximum of 4 Service Fixtures per Hood)		
5170015	SF-1G50	European Style Service Fixture with 50 mm Thread Length - Gas
5170004	SF-1V50	European Style Service Fixture with 50 mm Thread Length - Vacuum
5170012	SF-1N50	European Style Service Fixture with 50 mm Thread Length - Nitrogen
5170007	SF-1A50	European Style Service Fixture with 50 mm Thread Length - Air
5170009	SF-1W50	European Style Service Fixture with 50 mm Thread Length - Water
5170019	SF-2U50	American Style Service Fixture with 50 mm Thread Length - Universal
Others		
5170334	VOC-SR	VOC sensor for filter saturation detection
	EO-	Panel Mounted Electrical Outlet
5170001	WF-PP	Epoxy-coated Swan-neck faucet and Polypropylene drip-cup sink
5170127	MEW Rest	Ergonomic PVC Arm Rest Padding
1150006	LDAR-360	Ergonomic Laboratory Chair
5170073	FT Rest	Foot Rest



SPC-_Gen2



SAL-_Gen2



BCC-4_0



MBC-_



EO-H_



WF-PP



SF-2U_



SF-1_

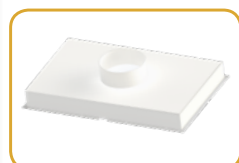

ECO-_



VOC-SR

MAIN CARBON FILTER

Hood Model	Filter Quantity	Filter Item Code	Filter Model Code	Description
ADC-2B	1	5080003	CFA-11	Standard filter
		5080095	CFB-11	Acid Filter
		5080028	CFC-11	Mercury Filter
		5080039	CFD-11	Sulphur Filter
		5080050	CFE-11	Halogen Filter
		5080061	CFF-11	Aldehyde Filter
		5080072	CFG-11	Ammonia / Amine Filter
		5080104	CFH-11	Ethers / Chloroforms Filter
ADC-3B/C/D/E	2	5080001	CFA-1	Standard filter
		5080017	CFB-1	Acid Filter
		5080026	CFC-1	Mercury Filter
		5080037	CFD-1	Sulphur Filter
		5080048	CFE-1	Halogen Filter
		5080059	CFF-1	Aldehyde Filter
		5080070	CFG-1	Ammonia / Amine Filter
		5080133	CFH-1	Ethers / Chloroforms Filter
ADC-4B/C/D/E	2	5080010	CFA-2	Standard filter
		5080019	CFB-2	Acid Filter
		5080030	CFC-2	Mercury Filter
		5080041	CFD-2	Sulphur Filter
ADC-6B/C/D/E	3	5080052	CFE-2	Halogen Filter
		5080063	CFF-2	Aldehyde Filter
		5080074	CFG-2	Ammonia / Amine Filter
		5080120	CFH-2	Ethers / Chloroforms Filter
ADC-5B/C/D/E	2	5080011	CFA-3	Standard filter
		5080020	CFB-3	Acid Filter
		5080031	CFC-3	Mercury Filter
		5080042	CFD-3	Sulphur Filter
		5080053	CFE-3	Halogen Filter
		5080064	CFF-3	Aldehyde Filter
		5080075	CFG-3	Ammonia / Amine Filter
		5080100	CFH-3	Ethers / Chloroforms Filter
SPD-4A/B	2	5080012	CFA-4	Standard filter
		5080021	CFB-4	Acid Filter
		5080032	CFC-4	Mercury Filter
		5080043	CFD-4	Sulphur Filter
		5080054	CFE-4	Halogen Filter
		5080065	CFF-4	Aldehyde Filter
		5080076	CFG-4	Ammonia / Amine Filter
		5080110	CFH-4	Ethers / Chloroforms Filter
SPD-3A/B	1	5080013	CFA-6	Standard filter
		5080022	CFB-6	Acid Filter
		5080033	CFC-6	Mercury Filter
		5080044	CFD-6	Sulphur Filter
		5080055	CFE-6	Halogen Filter
		5080066	CFF-6	Aldehyde Filter
		5080077	CFG-6	Ammonia / Amine Filter
		5080111	CFH-6	Ethers / Chloroforms Filter

SECONDARY FILTERS

Hood Model	Filter Quantity	Filter Item Code	Filter Model Code	Description
ADC-3C	1	5080014	CFA-7	Standard filter
		5080023	CFB-7	Acid Filter
		5080034	CFC-7	Mercury Filter
		5080045	CFD-7	Sulphur Filter
		5080056	CFE-7	Halogen Filter
		5080067	CFF-7	Aldehyde Filter
		5080078	CFG-7	Ammonia / Amine Filter
		5080108	CFH-7	Ethers / Chloroforms Filter
ADC-4C	1	5080015	CFA-8	Standard filter
		5080024	CFB-8	Acid Filter
		5080035	CFC-8	Mercury Filter
		5080046	CFD-8	Sulphur Filter
		5080057	CFE-8	Halogen Filter
		5080068	CFF-8	Aldehyde Filter
		5080079	CFG-8	Ammonia / Amine Filter
		5080101	CFH-8	Ethers / Chloroforms Filter
ADC-5C	1	5080016	CFA-9	Standard filter
		5080025	CFB-9	Acid Filter
		5080036	CFC-9	Mercury Filter
		5080047	CFD-9	Sulphur Filter
		5080058	CFE-9	Halogen Filter
		5080069	CFF-9	Aldehyde Filter
		5080080	CFG-9	Ammonia / Amine Filter
		5080127	CFH-9	Ethers / Chloroforms Filter
ADC-6C	2	5080002	CFA-10	Standard filter
		5080018	CFB-10	Acid Filter
		5080027	CFC-10	Mercury Filter
		5080038	CFD-10	Sulphur Filter
		5080049	CFE-10	Halogen Filter
		5080060	CFF-10	Aldehyde Filter
		5080071	CFG-10	Ammonia / Amine Filter
		5080105	CFH-10	Ethers / Chloroforms Filter
ADC-3E	1	1100069	HP-ADC3E	Exhaust HEPA Filter for ADC-3E
ADC-4E	1	1100056	HP-ADC4E	Exhaust HEPA Filter for ADC-4E
ADC-5E	1	1100080	HP-ADC5E	Exhaust HEPA Filter for ADC-5E



Esco Micro Pte. Ltd. • 21 Changi South Street 1 • Singapore 486 777
 Tel +65 6542 0833 • Fax +65 6542 6920 • mail@escolifesciences.com
 www.escolifesciences.com

Esco Technologies, Inc. • 903 Sheehy Drive, Suite F, Horsham, PA 19044, USA
 Tel: +1 215-441-9661 • Fax 484-698-7757
 eti.admin@escolifesciences.com

Esco Lifesciences Group Offices: Bangladesh | China | Denmark | Germany | Hong Kong | India | Indonesia | Italy | Japan | Lithuania
 | Malaysia | Myanmar | Philippines | Russia | Singapore | South Africa | South Korea | Taiwan | Thailand | UAE | UK | USA | Vietnam